



U.S. Department of
Homeland Security

United States
Coast Guard



BOAT CREW HANDBOOK – Boat Operations



Sumner I. Kimball, USLSS

BCH16114.1B
September 2020

Sumner Increase Kimball, USLSS

A young lawyer from Maine, Sumner I. Kimball was appointed as the chief of the Treasury Department's Revenue Marine Division in 1871. He had joined the Treasury Department as a clerk 10 years earlier and had proven his abilities as a manager. Using his hard-earned political know-how, and a good dose of Yankee common sense, Kimball proceeded to completely overhaul the Revenue Marine and the hodge-podge system of lifesaving stations along the nation's coast that were also under the control of the Revenue Marine Division. His impact on both organizations would prove to be immeasurable.

After the Civil War, the Revenue Marine, and the executive branch agencies generally, came under intense Congressional scrutiny. Economy was the name of the game during this time and expenditures were scrutinized across the board. Hence, Kimball decided to order the construction of new cutters not with iron hulls, which entailed considerable expense, but with proven wood hulls. The total number of petty officers and enlisted men was substantially cut and their pay reduced. Kimball also carried out a vigorous "housecleaning" of incompetent Revenue Marine officers and saw to it that discipline was tightened. A special object of his censure was the use of cutters as personal yachts by local Custom officials, a wide-spread abuse during that time. Kimball also put into effect a merit system to determine promotions. He also made one other great contribution to the quality of the Revenue Marine by establishing, in 1877, a School of Instruction, to train young officers. From this move developed today's Coast Guard Academy, which still trains the majority of the Coast Guard's career officers. But his greatest impact came with his work with what would become the U.S. Life-Saving Service.

Since 1848 Congress had been funding strictly volunteer stations, paying for the station and its equipment but relying on the local community to provide unpaid crews when needed. Kimball drew up regulations that set standards for personnel performance, physical standards and station routines. He convinced a parsimonious Congress to increase the funding of the Service to provide for full-time, paid crews, led under the direction of an appointed keeper. New stations were constructed around the coast and were equipped with the finest lifesaving equipment available. In 1878, this growing network of stations was organized as a separate agency of the Treasury Department and was named the U.S. Life-Saving Service. Kimball was chosen as the General Superintendent of the new service. He served in that capacity during the entire existence of the Life-Saving Service until it was merged with the Revenue Cutter Service in 1915 to form the new U.S. Coast Guard.

Retrieved from: https://www.uscg.mil/history/people/Sumner_Kimball.asp



BCH 16114.1B
SEP 9, 2020

BOAT CREW HANDBOOK – BOAT OPERATIONS – BCH16114.1B

Subj: BOAT CREW HANDBOOK – BOAT OPERATIONS

- Ref:
- a. *U.S. Coast Guard Boat Operations and Training (BOAT) Manual, Volume I*, COMDTINST M16114.32 (series)
 - b. *U.S. Coast Guard Boat Operations and Training (BOAT) Manual, Volume II*, COMDTINST M16114.33 (series)
 - c. *(FOUO) U.S. Coast Guard Boat Operations and Training (BOAT) Manual, Volume III*, COMDTINST M16114.42 (series)
 - d. *Auxiliary Boat Crew Qualification Guide, Volume I*, COMDTINST M16794.52 (series)
 - e. *Crewman and Coxswain*, COMDTINST M16794.52 (series)
 - f. *Auxiliary Boat Crew Qualification Guide, Volume II*, COMDTINST M16794.53 (series)
 - g. *Auxiliary Operations Policy Manual*, COMDTINST M16798.3 (series)
 - h. *Operational Risk Management*, COMDTINST 3500.3 (series)
 - i. *United States Coast Guard Regulations 1992*, COMDTINST M5000.3 (series)
 - j. *U.S. Coast Guard Addendum to the United States National Search and Rescue Supplement (NSS) to the International Aeronautical and Maritime Search and Rescue Manual (IAMSAR)*, COMDTINST M16130.2 (series)
 - k. *Boat Crew Handbook: Seamanship Fundamentals*, BCH16114.4 (series)
 - l. *Shipboard Lookout Manual*, COMDTINST M9450.1 (series)
 - m. *The U.S. Coast Guard Addendum to the United States National Search and Rescue Supplement (NSS) to the International Aeronautical and Maritime Search and Rescue Manual (IAMSAR)*, COMDTINST M16130.2 (series)

1. PURPOSE. The purpose of this handbook presents the approved methods and procedures for the conduct of Coast Guard boat operations. Major topics within this handbook are boat crew duties and responsibilities, towing, person in the water recovery, rescue assistance and fire fighting, and air operations.
2. DIRECTIVES AFFECTED. The Boat Crew Operations Handbook, BCH16114.1A, is canceled.
3. DISCUSSION. This Handbook provides guidance on how to engage in safe and effective boat operations.

4. MAJOR CHANGES. Major changes to this BCH are as follows:
 - a. In Chapter 3, C.44. Towing at a Safe Speed, restored original-issue language regarding maximum towing speed.
 - b. In Chapter 3, D.8. Working Turn (and in Glossary), updated working turn definition.
 - c. In Chapter 4, A.31. Stokes Litter and subparagraphs, updated photo and strap wording, including strap color sequence.
5. DISCLAIMER. This guidance is not a substitute for applicable legal requirements, nor is it itself a rule. It is intended to provide operational guidance for Coast Guard personnel and is not intended to nor does it impose legally-binding requirements on any party outside the Coast Guard.
6. ENVIRONMENTAL ASPECT AND IMPACT CONSIDERATIONS. Environmental aspects and impact considerations were examined in the development of this Handbook and have been determined to be not applicable.
 - a. The development of this Handbook and the general policies contained within it have been thoroughly reviewed by the originating office in conjunction with the Office of Environmental Management, Commandant (CG-47). This Handbook is categorically excluded under current Department of Homeland Security (DHS) categorical exclusion DHS (CATEX) A3 from further environmental analysis in accordance with the U.S. Coast Guard Environmental Planning Policy, COMDTINST 5090.1 and the Environmental Planning (EP) Implementing Procedures (IP).
 - b. This Handbook will not have any of the following: significant cumulative impacts on the human environment; substantial controversy or substantial change to existing environmental conditions; or inconsistencies with any Federal, State, or local laws or administrative determinations relating to the environment. All future specific actions resulting from the general policy in this Handbook must be individually evaluated for compliance with the National Environmental Policy Act (NEPA) and Environmental Effects Abroad of Major Federal Actions, Executive Order 12114, Department of Homeland Security (DHS) NEPA policy, Coast Guard Environmental Planning policy, and compliance with all other applicable environmental mandates.
7. DISTRIBUTION. No paper distribution will be made of this Handbook. An electronic version will be located on the Office of Boat Forces (CG-731) Portal site: <https://cg.portal.uscg.mil/units/cg731/SitePages/Manuals.aspx>.
8. FORMS/REPORTS. None.

9. REQUESTS FOR CHANGES. To recommend edits and changes to this Handbook, please submit a formal request at the following link:
<https://cg.portal.uscg.mil/communities/bfco/doctrine/SitePages/Questions%20%20Recommendations.aspx>.

J. BRIAN RUSH /s/
U.S. Coast Guard
Chief, Office of Boat Forces



Table of Contents

CHAPTER 1 INTRODUCTION	1-1
SECTION A. PURPOSE OF THIS HANDBOOK	1-2
SECTION B. HOW TO USE THIS HANDBOOK	1-3
<i>Chapter Layout</i>	1-3
<i>Warnings, Cautions, and Notes</i>	1-3
CHAPTER 2 BOAT CREW DUTIES AND RESPONSIBILITIES	2-1
<i>Introduction</i>	2-1
<i>In this Chapter</i>	2-1
SECTION A. BOAT CREW MANAGEMENT	2-2
A.1. Coxswain Responsibilities	2-2
A.2. Boat Crew Member / Engineer Responsibilities	2-3
A.3. Effective Communications	2-3
A.4. Mission Execution	2-3
SECTION B. THE BOAT CREW	2-4
B.1. Qualification and Certification	2-4
B.2. The Auxiliary	2-4
SECTION C. BOAT CREW DUTIES	2-5
<i>Trainee</i>	2-5
C.1. Description	2-5
C.2. Knowledge and Performance Skills	2-5
<i>Boat Crew Member</i>	2-6
C.3. Description	2-6
C.4. Knowledge and Performance Skills	2-6
<i>Engineer</i>	2-7
C.5. Description	2-7
C.6. Knowledge and Performance Skills	2-7
<i>Coxswain/Operator</i>	2-8
C.7. Description	2-8
C.8. Knowledge and Performance Skills	2-9
SECTION D. BOAT CREWMEMBER RESPONSIBILITIES	2-10
<i>Lookout Watch</i>	2-10
D.1. Description	2-10
D.2. Assign and Station	2-10
D.3. Guidelines	2-11
D.4. Lookout Positioning	2-12
D.5. Lookout Equipment	2-13
D.6. Object Identification	2-13
D.7. Relative Bearings	2-14
D.8. Reporting Procedures	2-15
D.9. Position Angle	2-16
D.10. Distance	2-16
D.11. Making Reports	2-16
D.12. Scanning	2-17
D.13. Fog Scanning	2-18
<i>Night Lookout Watch</i>	2-18
D.14. Description	2-18
D.15. Guidelines	2-18
D.16. Dark Adaptation	2-18



D.17. Night Scanning..... 2-19

D.18. Night Fog 2-19

D.19. Night Vision Devices (AN/PVS-14 MNVD)..... 2-19

D.20. Thermal Imaging Devices 2-20

Helmsman..... 2-22

D.21. Description 2-22

D.22. Guidelines..... 2-22

Anchor Watch 2-22

D.23. Description 2-22

D.24. Guidelines..... 2-23

D.25. Checking for Chafing 2-23

D.26. Checking for Dragging 2-23

D.27. Checking Position 2-23

Towing Watch..... 2-24

D.28. Towing Watch 2-24

D.29. Tow Watch Guidelines 2-24

D.30. Observed Danger..... 2-24

D.31. Maintaining Watch 2-25

SECTION E. CREW FATIGUE..... 2-26

Introduction 2-26

In this Section..... 2-26

E.1. Fatigue 2-26

E.2. Crew Responsibility..... 2-27

E.3. Symptoms 2-27

E.4. Prevention 2-27

E.5. Environmental Conditions 2-28

SECTION F. DRUGS AND ALCOHOL 2-29

Introduction 2-29

In this Section..... 2-29

F.1. Prescription Drugs..... 2-29

F.2. Alcohol 2-29

F.3. Tobacco..... 2-30

F.4. Caffeine..... 2-30

CHAPTER 3 TOWING 3-1

SECTION A. TOWING FORCES 3-2

Towing Forces..... 3-3

A.1. Towing Safety 3-3

A.2. Towing Forces..... 3-4

Dynamic Forces..... 3-7

A.3. Dynamic Forces 3-7

A.4. Momentum 3-7

A.5. Angular Momentum 3-7

A.6. Frictional Resistance..... 3-7

A.7. Form Drag..... 3-8

A.8. Wave-Making Resistance 3-8

A.9. Wave Drag, Spray Drag, and Wind Drag..... 3-9

A.10. Buoyancy Response and Gravity Effects..... 3-10

Combination of Forces and Shock-Load..... 3-10

A.11. Combination of Forces and Shock-Load 3-10

A.12. Example 3-10

A.13. Shock-Loading Prevention or Counteraction..... 3-11

SECTION B. TOWING EQUIPMENT 3-13

Towlines and Accessories..... 3-13

B.1. Description 3-13

B.2. Towing Pendants and Bridles 3-15



<i>Heaving Line</i>	3-18
B.3. Description	3-18
B.4. Passing a Towline.....	3-18
<i>Chafing Gear</i>	3-20
B.5. Description	3-20
B.6. Preventing Chafing Damage	3-20
B.7. Thimbles	3-20
<i>Deck Fittings and Other Fittings</i>	3-21
B.8. Description	3-21
B.9. Condition and Inspection.....	3-21
B.10. Skiff Hook.....	3-22
<i>Drogues</i>	3-23
B.11. Description	3-23
B.12. Inspection and Preparing the Drogue Gear	3-25
B.13. Directly Passing the Drogue.....	3-26
B.14. Rigging the Drogue for Deployment.....	3-26
B.15. Deploying the Drogue.....	3-27
B.16. Shortening Up and Recovering Drogue	3-28
B.17. Storing Drogue.....	3-28
<i>Other Equipment</i>	3-28
B.18. Description	3-28
B.19. Alongside Lines.....	3-28
B.20. Fenders	3-29
B.21. General Hardware	3-29
SECTION C. STANDARD TOWING PROCEDURES	3-30
<i>Pre-Towing Procedures</i>	3-30
C.1. Description	3-30
C.2. Receiving Notification and Accepting Task.....	3-31
C.3. Briefing the Crew	3-31
C.4. Evaluating Conditions	3-32
C.5. Operating and Navigating the Vessel Safely.....	3-32
C.6. Communicating with Distressed Vessel.....	3-33
C.7. Preparing Equipment.....	3-33
C.8. Performing an On-Scene Assessment.....	3-34
C.9. Making-Up the Tow Rig and Preparing for Transfer	3-35
C.10. Determining the Approach	3-35
C.11. Briefing the Distressed Vessel	3-36
<i>Towing Astern</i>	3-36
C.12. Description	3-36
C.13. Establishing a Danger Zone.....	3-37
C.14. Making the Approach	3-37
C.15. Safe Distance	3-37
C.16. Optimum Position.....	3-38
C.17. Maneuvering Zone.....	3-39
C.18. Maneuvering to an Optimum Position	3-40
C.19. Station Keeping While in Optimum Position	3-41
C.20. Passing the Tow Rig	3-42
C.21. Opening and Closing Maneuvers while Towing.....	3-45
C.22. Opening by Pivoting.....	3-45
C.23. Opening by Backing	3-46
C.24. Closing by Backing	3-46
C.25. Closing by Quartering	3-47
C.26. Connecting the Tow Rig.....	3-48
<i>Connecting Tow Rig to Fittings</i>	3-49
C.27. Description	3-49
C.28. Ensuring a Fair Lead.....	3-49
C.29. Making Fast to Fittings	3-50



C.30. Installing Chafing Gear	3-51
<i>Connecting Tow Rig to a Trailer Eye</i>	3-51
C.31. Description	3-51
C.32. Attaching the Skiff Hook	3-51
<i>Transitioning to Stern Tow</i>	3-52
C.33. Moving Away	3-52
C.34. Maneuvering to Pay-Out Course	3-53
C.35. Paying-Out the Tow Line.....	3-53
C.36. Making Up the Bitt.....	3-53
C.37. Setting a Towing Watch.....	3-53
<i>Underway With Stern Tow</i>	3-54
C.38. Description	3-54
C.39. Briefing the Towed Vessel	3-54
C.40. Deploying Drogue	3-54
C.41. Maintaining a Catenary	3-54
C.42. Staying in Step	3-55
C.43. Minimizing Yaw.....	3-56
C.44. Towing at a Safe Speed.....	3-57
<i>Compensating for Current</i>	3-59
C.45. Description	3-59
C.46. Head Current	3-60
C.47. Tail Current	3-62
C.48. Cross Current	3-63
C.49. Combinations of Currents.....	3-65
<i>Shortening the Tow</i>	3-65
C.50. Description	3-65
C.51. Before Shortening a Tow	3-66
C.52. Shorten the Tow	3-67
C.53. Maintaining Control in Rough Conditions.....	3-68
C.54. Disconnecting Tow or Towing Alongside	3-69
C.55. Disconnecting the Towline	3-69
<i>Towing Alongside</i>	3-70
C.56. Description	3-70
C.57. Preparation.....	3-71
C.58. Making the Approach	3-73
C.59. Rigging Additional Lines Alongside	3-73
C.60. Maneuvering	3-74
<i>Sinking Tows</i>	3-75
C.61. Description	3-75
C.62. Minimizing the Danger	3-76
C.63. Marking the Wreck	3-76
SECTION D. TOWING IN HEAVY WEATHER	3-77
<i>Before Approach</i>	3-77
D.1. Vessel to be Towed	3-77
D.2. Before Approaching	3-78
<i>Approach</i>	3-78
D.3. Towing Approaches.....	3-78
D.4. Approach Determining Factors	3-79
D.5. Bow-to-Swell Approach.....	3-80
D.6. Stern-to-Swell Approach	3-81
<i>Towing Procedures</i>	3-82
D.7. Passing the Towline in Heavy Weather	3-82
D.8. Working Turn.....	3-82
D.9. Towing Transition.....	3-83
D.10. Towing Astern	3-84
D.11. Towing in Following Seas	3-85



D.12. Towing into Heavy Seas.....	3-86
D.13. Towing Beam to the Seas.....	3-86
D.14. Shortening Tow.....	3-87
D.15. Precautions.....	3-88
D.16. Emergency Towing a Disabled Boat from the Surf.....	3-88
CHAPTER 4 PERSON-IN-THE-WATER (PIW) RECOVERY	4-1
SECTION A. RECOVERY METHODS	4-2
<i>General Person-In-the-Water Procedure</i>	<i>4-2</i>
A.1. Description	4-2
A.2. Prevention	4-3
A.3. First Sighting.....	4-3
A.4. Coxswain or Operator Actions.....	4-4
A.5. Maneuvering Boat to Recover PIW	4-5
A.6. Mark Position	4-5
A.7. Alerting Boats in the General Vicinity.....	4-5
A.8. Deploying a Flotation Device.....	4-6
A.9. Assigning Crew Duties	4-7
A.10. Crew Briefing.....	4-7
A.11. Informing the Operational Commander.....	4-8
A.12. Urgent Marine Information Broadcasts (UMIB).....	4-8
A.13. Requesting Additional Assistance.....	4-8
A.14. Summary	4-9
<i>Pick Up Methods.....</i>	<i>4-10</i>
A.15. Description	4-10
<i>The Approach.....</i>	<i>4-10</i>
A.16. Description	4-10
A.17. Leeward Approach	4-11
A.18. Windward Approach	4-12
A.19. Windward to Leeward of Multiple PIWs	4-13
A.20. Stopping Immediately	4-13
A.21. Slow/Stop, Turn/Pivot Return	4-13
<i>Approaching in Low Visibility.....</i>	<i>4-14</i>
A.22. Description	4-14
A.23. Williamson Turn	4-14
<i>Recovery</i>	<i>4-18</i>
A.24. Description	4-18
A.25. Recovery Methods.....	4-18
A.26. Person Overboard is Uninjured and Conscious	4-18
A.27. PIW Is Unconscious or Injured.....	4-20
A.28. Boat Swimmer	4-20
A.29. Tending Line Commands	4-21
A.30. Boat Swimmer Deployment	4-22
A.31. Stokes Litter.....	4-23
A.32. Multiple PIW Recovery.....	4-24
SECTION B. PIW WHILE TOWING	4-25
<i>PIW While Towing.....</i>	<i>4-25</i>
B.1. Vessel Maneuverability	4-25
SECTION C. HEAVY WEATHER/SURF PIW RECOVERY.....	4-28
<i>Person-In-the-Water</i>	<i>4-28</i>
C.1. PIW Procedure.....	4-28
C.2. Down Swell Run.....	4-28
C.3. Spacing.....	4-29
C.4. Approach	4-30
C.5. The Recovery	4-30
C.6. Recovery of a Conscious Person from the Water	4-31



C.7. Recovery of an Unconscious PIW 4-31
 C.8. Use of a Boat Swimmer 4-32
 C.9. Multiple PIWs 4-32

CHAPTER 5 RESCUE, ASSISTANCE, AND FIRE FIGHTING 5-1

SECTION A. SAFETY AND DAMAGE CONTROL 5-2
 A.1. Safety Assessment and Management Guidelines 5-2
 SECTION B. FLOOD CONTROL AND DEWATERING 5-4
Plugging Holes 5-4
 B.1. Plugs 5-4
 B.2. Preparing Plug 5-4
 B.3. Inserting Plugs 5-5
 B.4. Large Holes 5-5
 B.5. Fiberglass Hulls 5-5
Patching Holes 5-5
 B.6. Holes Below the Waterline 5-5
 B.7. Large Holes Below the Waterline 5-6
 B.8. Holes above the Waterline 5-7
Patching Cracks 5-8
 B.9. Cracks in Hulls 5-8
Dewatering 5-8
 B.10. Introduction 5-8
 B.11. Action Before Dewatering 5-8
 B.12. Dewatering with an Eductor 5-9
 B.13. Dewatering Using a Drop Pump 5-10
 SECTION C. FIRE FIGHTING 5-19
Policy 5-19
 C.1. Coast Guard Fire Fighting Activities Policy 5-19
Preventive Actions 5-20
 C.2. Description 5-20
 C.3. Measures of Practice 5-20
Susceptible Areas 5-20
 C.4. Spontaneous Ignition 5-20
 C.5. Engine Room Fires 5-21
 C.6. Electrical Circuits and Equipment 5-22
 SECTION D. FIRE THEORY, CLASSIFICATIONS, AND FUEL SOURCES 5-24
 D.1. Fire Theory 5-24
 D.2. Classification of Fires and Fuel Sources 5-25
 SECTION E. FIRE FIGHTING EQUIPMENT 5-26
Fire Hose 5-26
 E.1. Description 5-26
 E.2. Safety Precautions 5-26
 E.3. Minimum Operators 5-27
 E.4. Coupling 5-27
Spanner Wrench 5-27
 E.5. Description 5-27
 E.6. Safety Precautions 5-27
 E.7. Operation 5-28
Vari-Nozzle 5-28
 E.8. Description 5-28
 E.9. Operation 5-29
CG-P6 Portable Dewatering Pump with Attached Fire Fighting Hose and Nozzle 5-29
 E.10. Description 5-29
 E.11. Minimum Operators 5-29
 E.12. CG-P6 Dewatering Pump 5-29
 E.13. Fire Fighting Hose 5-30



E.14. Fire Fighting Nozzle.....	5-30
E.15. Quick Connection Coupling (Applicable Assets).....	5-31
E.16. CG-P6 Discharge Outlet Adapter.....	5-31
E.17. Fire Fighting Hose and Nozzle Operation.....	5-32
E.18. Securing in an Emergency.....	5-34
SECTION F. DESCRIPTION AND APPLICATION OF EXTINGUISHING AGENTS.....	5-35
<i>How Extinguishing Agents Work</i>	5-35
F.1. Description.....	5-35
<i>Applying Water</i>	5-36
F.2. Description.....	5-36
F.3. Straight Stream	5-36
F.4. Narrow Fog	5-37
F.5. Wide Fog	5-38
F.6. Effectiveness.....	5-38
F.7. Adapting Equipment	5-38
<i>Applying Aqueous Film-Forming Foam (AFFF)</i>	5-39
F.8. Description.....	5-39
F.9. Effectiveness.....	5-39
<i>Applying Chemical Agents</i>	5-40
F.10. Description.....	5-40
F.11. Carbon Dioxide (CO ₂)	5-40
F.12. Dry Chemical / Potassium Bicarbonate (PKP)	5-43
<i>Fire Suppressions Systems</i>	5-45
F.13. Description.....	5-45
F.14. Types.....	5-45
SECTION G. FIRE FIGHTING PROCEDURES.....	5-46
G.1. Coast Guard’s Fire Fighting Duty.....	5-46
G.2. Safety Precautions.....	5-47
G.3. Action	5-48
SECTION H. EXTINGUISHING FIRES.....	5-52
H.1. Safety Rules	5-52
H.2. Fire Combat	5-53
H.3. Direct Attack.....	5-53
H.4. Indirect Attack.....	5-53
H.5. Fire Fighting Procedures Onboard Own Boat.....	5-53
H.6. Fire Fighting Procedures on Auxiliary Boats	5-56
H.7. Fires Aboard Other Boats	5-58
H.8. Fire Under Control.....	5-58
H.9. Fire Extinguished	5-59
H.10. Abandoning a Coast Guard Boat	5-59
CHAPTER 6 AIR OPERATIONS	6-1
SECTION A. HELICOPTERS AND EQUIPMENT.....	6-2
A.1. MH-65 Dolphin	6-3
A.2. MH-60 Jayhawk	6-4
A.3. Helicopter Equipment	6-5
A.4. Trail Line	6-7
A.5. Weak Link	6-8
A.6. Dewatering Pump Kits	6-8
SECTION B. HELICOPTER RESCUE OPERATIONS	6-9
<i>Rescue Swimmer</i>	6-9
B.1. Description	6-9
<i>Helicopter Hoisting Operations</i>	6-9
B.2. Description	6-9
B.3. Boat Crew Preparations for Hoisting	6-10
B.4. Boat Crew Positions on Deck	6-13



B.5. Boat Crew Safety Precautions	6-15
<i>Helicopter-Boat Positioning</i>	<i>6-16</i>
B.6. Description	6-16
B.7. Course and Speed	6-16
B.8. Nonstandard Boats	6-17
B.9. Helicopter-Boat Configuration	6-17
B.10. Dead-in-the-Water	6-18
<i>Delivery of the Rescue Device</i>	<i>6-19</i>
B.11. Description	6-19
B.12. Direct Delivery	6-19
B.13. Trail-Line Delivery	6-20
B.14. Indirect Delivery	6-21
<i>Hoisting</i>	<i>6-22</i>
B.15. Description	6-22
B.16. Basket Hoist	6-23
B.17. Stokes Litter Hoist	6-24
B.18. Rescue Strop Hoist	6-24
B.19. Hoisting of Equipment	6-24
B.20. Commencing Hoist	6-24
B.21. Casting Off	6-24
B.22. Post Hoist	6-24
B.23. Fouled Cable/Equipment Procedure	6-24
B.24. Emergency Breakaway Procedure	6-26
B.25. Boat Casualties During Hoisting (Committed)	6-26
SECTION C. HELICOPTER DITCHING	6-27
C.1. Assisting a Downed Helicopter	6-30
SECTION D. FIXED-WING AIRCRAFT	6-31
D.1. Auxiliary Aircraft	6-31
D.2. Communications with Aircraft	6-31
APPENDIX A GLOSSARY	A-1
APPENDIX B LIST OF ACRONYMS	B-1



Table of Figures

FIGURE 2-1 RELATIVE BEARINGS	2-14
FIGURE 2-2 POSITION ANGLES	2-16
FIGURE 2-3 WHITE HOT THERMAL DISPLAY.....	2-21
FIGURE 2-4 BLACK HOT THERMAL DISPLAY	2-21
FIGURE 3-1 STATIC FORCES	3-5
FIGURE 3-2 DYNAMIC FORCES	3-7
FIGURE 3-3 PENDANT	3-16
FIGURE 3-4 BRIDLE/CATS PAW	3-17
FIGURE 3-5 HEAVING LINES.....	3-19
FIGURE 3-6 THIMBLES.....	3-20
FIGURE 3-7 SKIFF HOOK	3-22
FIGURE 3-8 MODERN DROGUE TYPES	3-24
FIGURE 3-9 DANGER ZONES	3-37
FIGURE 3-10 OPTIMUM POSITION.....	3-38
FIGURE 3-11 MANEUVERING ZONE	3-39
FIGURE 3-12 OPTIMUM POSITION FOR PASSING THE TOW RIG	3-42
FIGURE 3-13 BRIDLE AND TRAILER EYEBOLT TOW RIG CONNECTION	3-48
FIGURE 3-14 TOWLINE CONNECTION SHOWING BRIDLE ANGLE	3-50
FIGURE 3-15 SCOPE OF TOWLINE WITH CATENARY	3-55
FIGURE 3-16 CALCULATED SAFE TOWING SPEEDS.....	3-58
FIGURE 3-17 HEAD CURRENT	3-60
FIGURE 3-18 TAIL CURRENT	3-62
FIGURE 3-19 EFFECTS OF CROSS CURRENT.....	3-64
FIGURE 3-20 SIDE TOW.....	3-70
FIGURE 3-21 BOW-TO-SWELL APPROACH.....	3-80
FIGURE 3-22 STERN-TO-SWELL APPROACH	3-81
FIGURE 4-1 RING BUOY WITH STROBE/THROWABLE DEVICE.....	4-6
FIGURE 4-2 LEEWARD APPROACH.....	4-11
FIGURE 4-3 WINDWARD APPROACH	4-12
FIGURE 4-4 WINDWARD TO LEEWARD APPROACH OF MULTIPLE PIWs	4-13
FIGURE 4-5 WILLIAMSON TURN	4-16
FIGURE 4-6 RECOVERING THE PIW AT THE SURFACE OF THE WATER	4-19
FIGURE 4-7 RECOVERING A PIW HANDS UNDER ARMPITS	4-19
FIGURE 4-8 BOAT SWIMMER HARNESS.....	4-22
FIGURE 4-9 CROSS-SHOULDER POSITION	4-22
FIGURE 4-10 STOKES LITTER.....	4-23
FIGURE 4-11 SPACING WHILE TRAVELING DOWN SWELL.....	4-29
FIGURE 5-1 SCREW EYE	5-5
FIGURE 5-2 COLLISION MAT.....	5-6
FIGURE 5-3 PATCHING HOLE ABOVE WATERLINE	5-7
FIGURE 5-4 EDUCTOR RIGGED FOR DEWATERING	5-10
FIGURE 5-5 DROP PUMP.....	5-11
FIGURE 5-6 DROP PUMP READIED FOR DEWATERING ACTION	5-13
FIGURE 5-7 SECURING LINES TO DROP PUMP CONTAINER	5-14
FIGURE 5-8 DIRECTLY PASSING A DROP PUMP USING TENDING LINES	5-15
FIGURE 5-9 DROP PUMP ON THE TOWLINE.....	5-17
FIGURE 5-10 PASSING A DROP PUMP ON THE TOWLINE.....	5-17
FIGURE 5-11 FIRE TETRAHEDRON.....	5-24
FIGURE 5-12 FIRE FIGHTING HOSE WITH MALE AND FEMALE COUPLINGS	5-27
FIGURE 5-13 SPANNER WRENCH	5-28



FIGURE 5-14 VARI-NOZZLE 5-29
FIGURE 5-15 FIRE FIGHTING HOSE 5-30
FIGURE 5-16 FIRE FIGHTING NOZZLE 5-30
FIGURE 5-17 SUCTION HOSE 5-31
FIGURE 5-18 COLOR-CODED COUPLING 5-31
FIGURE 5-19 CG-P6 PUMP WITH FIRE FIGHTING HOSE AND NOZZLE ATTACHMENTS 5-32
FIGURE 5-20 OPERATING THE CO2 EXTINGUISHER 5-42
FIGURE 5-21 DRY CHEMICAL EXTINGUISHER 5-44
FIGURE 5-22 APPROACHING A BOAT ON FIRE 5-50
FIGURE 5-23 ACCESS HOLE/PLUG FOR EXTINGUISHING THE ENGINE COMPARTMENT 5-57
FIGURE 6-1 MH-65 (DOLPHIN) HELICOPTER 6-3
FIGURE 6-2 MH-60 (JAYHAWK) HELICOPTER 6-4
FIGURE 6-3 M/J RESCUE BASKET UNFOLDED POSITION 6-5
FIGURE 6-4 M/J RESCUE BASKET FOLDED POSITION 6-5
FIGURE 6-5 STOKES LITTER 6-6
FIGURE 6-6 RESCUE STROP 6-7
FIGURE 6-7 TRAIL LINE’S WEAK LINK 6-8
FIGURE 6-8 HAND SIGNALS BETWEEN BOAT AND HELICOPTER 6-12
FIGURE 6-9 HELICOPTER-BOAT HOIST 6-16
FIGURE 6-10 OVERHEAD VIEW OF DECK PERSONNEL, WITH M/J BASKET AND TRAIL LINE 6-17
FIGURE 6-11 OVERHEAD VIEW OF CREW POSITIONS DURING DIW HOIST 6-18
FIGURE 6-12 M/J RESCUE BASKET GOING DOWN 6-20
FIGURE 6-13 INDIRECT DELIVERY OF PUMP 6-21
FIGURE 6-14 PUMP IN THE WATER 6-21
FIGURE 6-15 M/J RESCUE BASKET WITH PERSON PROPERLY POSITIONED AND READY FOR HOIST 6-23
FIGURE 6-16 MH-60 EMERGENCY ENTRANCES 6-28
FIGURE 6-17 MH-65 EMERGENCY ENTRANCES 6-29
FIGURE 6-18 AIR-TO-SURFACE VISUAL SIGNALS 6-32

Table of Tables

TABLE 3-1 MAXIMUM TOWING SPEEDS 3-58



CHAPTER 1

Introduction

Introduction The Boat Operations Handbook presents the approved methods and procedures for the conduct of Coast Guard boat operations. The Coast Guard Auxiliary, for the conduct of vessel facility operations, also uses this Handbook.

The purpose of this Chapter is to explain how this Handbook works.

In this Chapter This Chapter contains the following sections:

Section	Title	See Page
A	Purpose of this Handbook	1-2
B	How to Use this Handbook	1-3



Section A. Purpose of this Handbook

Introduction

The purpose of this handbook presents the approved methods and procedures for the conduct of Coast Guard boat operations. Major topics within this handbook are boat crew duties and responsibilities, towing, person in the water recovery, rescue assistance and fire fighting, and air operations.

In this Section

This Section contains the following information:

Title	See Page
Procedures	1-2

Procedures

This Handbook is not intended to cover every contingency that may be encountered during mission execution or training. Successful operations require the exercise of good safety practices, sound judgment and common sense at all levels of command.



Section B. How to Use this Handbook

Introduction Each Chapter that follows in this Handbook includes its own table of contents and is divided into Sections.

In this Section This Section contains the following information:

Title	See Page
Chapter Layout	1-3
Warnings, Cautions, and Notes	1-3

Chapter Layout

The first page of each chapter includes an *Introduction*, and an *In this Chapter*, as applicable.

The first page of each section includes an *Introduction*, and *In this Section*, as applicable.

In the left column of each page are block titles, which provide a descriptive word or phrase for the corresponding block of text to the right.

Warnings, Cautions, and Notes

The following definitions apply to “Warnings, Cautions, and Notes” found throughout the Handbook.

WARNING 

Operating procedures or techniques that must be carefully followed to avoid personal injury or loss of life.

CAUTION !

Operating procedures or techniques that must be carefully followed to avoid equipment damage.

NOTE 

An operating procedure or technique that is essential to emphasize.



CHAPTER 2

Boat Crew Duties and Responsibilities

Introduction Boat crews perform duties requiring both skill and knowledge. This Chapter discusses general crew duties and related procedures for watchstanding necessary for the successful completion of missions. The general duties for crewmembers are outlined in this Chapter. Assignments and procedures for specific tasks, such as towing or retrieving people from the water, are found in other chapters.

In this Chapter This Chapter contains the following sections:

Section	Title	See Page
A	Boat Crew Management	2-2
B	The Boat Crew	2-4
C	Boat Crew Duties	2-5
D	Boat Crewmember Responsibilities	2-10
E	Crew Fatigue	2-26
F	Drugs and Alcohol	2-29



Section A. Boat Crew Management

Introduction Boat operations often involve high speeds, rough weather, close proximity to hazards, and emergency situations that place the boat crew and success of any mission at risk. Boat Crew Management is a broad range of activities that ensure the boat crew performs as a team, meaning they share the physical and mental workload of operating a boat platform in order to reduce risks by recognizing, trapping, and mitigating errors before they jeopardize the boat crew or its mission. This process begins with determining your crew complement, selecting the proper boat platform, and defining the mission goals. The process then extends through proper navigation, and ends with the exercise of good judgment in carrying out the operation.

In this Section This Section contains the following information:

Title	See Page
Coxswain Responsibilities	2-2
Boat Crew Member / Engineer Responsibilities	2-3
Effective Communications	2-3
Mission Execution	2-3

A.1. Coxswain Responsibilities

Roles and responsibilities of a coxswain are governed by Reference (i), which describe the coxswain as having the ultimate authority to issue orders to a boat crew without discussion in order to ensure the safety and conduct of passengers and crew, the safe operation and navigation of the boat assigned, and the completion of the mission or sortie. Coxswains will manage their crews and delegate tasks according to Coast Guard policy, procedures, individual preferences, a boat crew's ability, and mission requirements. A coxswain must rely on the entire boat crew to share the mental and physical workload by performing delegated tasks, providing input and feedback to mitigate risks, and carry out their qualified duties. Coxswains must be aware of the value and benefits of teamwork and avoid creating a dictatorship or attempting to perform every required task themselves.



A.2. Boat Crew Member / Engineer Responsibilities

Boat crew members and engineers have specific roles and responsibilities that are defined and discussed further in **Section B** of this chapter. Certified boat crews must be thoroughly familiar with their primary responsibilities and be prepared to assist or even assume other duties as directed by the coxswain. It is the responsibility of each member of the boat crew to offer suggestions and concerns that arise during any and all missions and scenarios, e.g. Rules of the Road situations, training, and/or safety. Boat Crewmembers/Engineers are also required to constantly assess the situation, voice concerns, and give recommendations to the coxswain regardless of the mission. This supports a more empowered way of working, removes constraints, and maximizes strengths.

A.3. Effective Communications

Effective communication is essential to the success of the boat crew and their missions. Communications between the coxswain and boat crew members helps to form highly efficient teams, mitigates unnecessary risk, and promotes collaboration between members. A boat crew that works together achieves high productivity, safe and effective boat operations, and, most importantly, a successful mission outcome. Additional communications between the boat crew, Sector Command Center, on-scene coordinators, and other key partners can provide proper coordination and continuous mission progression.

Boat crews should always communicate their observations and concerns or ask questions to the others on board, and repeat-backs should be used to ensure understanding. Everyone on the crew has a role in the decision-making process and must be allowed and encouraged to communicate openly and to provide recommendations regardless of their position, pay grade, or individual tasking.

A.4. Mission Execution

Mission Execution is the goals and targets set which are related to a team's successful completion of our 11 statutory missions. The coxswain is ultimately responsible for mission execution. Before confirming tasking and accepting the mission, boat crewmembers shall consider the boat platform and crew capability. Coxswains, engineers, and boat crewmembers must devote time to training individually and as a team in order to increase familiarity and attain proficiency.



Section B. The Boat Crew

Introduction There are three basic boat crew positions on boats:

- (01) Coxswain,
- (02) Engineer,
- (03) Crew member.

In this Section This Section contains the following information:

Title	See Page
Qualification and Certification	2-4
The Auxiliary	2-4

B.1. Qualification and Certification Boat crew members, engineers, and coxswains/operators are qualified and certified in accordance with agency policy. The Coast Guard uses References (a), (b), and (c). Auxiliarists' qualifications for crewing Auxiliary facilities are covered in References (d), (e), and (f).

B.2. The Auxiliary An auxiliarist on official orders may perform many Coast Guard duties, including boat crew member and boat engineer, but is not a military member of the Coast Guard. Although trained and qualified to an equivalent level, the Auxiliary member may not be assigned any authority or responsibility specifically reserved by regulation for military or law enforcement personnel.

The mission of Auxiliary operations is to provide operational, logistic, and training support to appropriate Coast Guard programs. 14 USC 826 and 831 authorize the Coast Guard to use suitably trained auxiliarists and Auxiliary facilities. The operational use of auxiliarists and their boats, aircraft, and radio stations is encouraged. Unit Commanders may use Auxiliary resources for missions already authorized by Commandant Policy and as outlined in *Chapter 1* of Reference (g).



Section C. Boat Crew Duties

Introduction Most boat crew training programs are based on the concept that sailors receive the best training while underway. This handbook, and specifically this Chapter, is designed to provide an outline of the duties typically performed by various members of boat crews and the skills and knowledge required to perform tasks assigned. For people seeking to be members of a boat crew, it is fundamental that they understand these duties and the importance of crewmembers working together as a team.

In this Section This Section contains the following information:

Title	See Page
Trainee	2-5
Boat Crew Member	2-6
Engineer	2-7
Coxswain	2-8

Descriptions and requirements for advanced qualifications (surfman, AtoN coxswain, heavy weather coxswain, advanced interdiction coxswain, etc.) are found in Reference (b).

Trainee

C.1. Description Trainees are members seeking to qualify as a boat crew member. The trainee rides onboard to observe actual operational missions and to gain “hands on” experience under the close direction of a qualified crew member. Agency specific policy dictates who may or may not be a trainee and the level and platforms with which they may operate.

C.2. Knowledge and Performance Skills The duties of a trainee are to learn and safely perform the practical tasks prescribed for crew members. For Coast Guard members, these duties are described in Reference (b) and are performed under the supervision of a qualified crew member assigned to the boat.



Boat Crew Member

C.3. Description Boat crew members safely perform their duties under the supervision of a coxswain. They perform the following duties:

- (01) Helmsman,
- (02) Lookout,
- (03) Towing watches,
- (04) Anchor watch,
- (05) Assist with piloting and navigation.

They also:

- (06) Rig towing and mooring lines,
- (07) Act as the boat swimmer,
- (08) Administer first aid,
- (09) Operate damage control equipment.

This position provides valuable training for future duties and responsibilities. It is the foundation for all other boat crew positions.

NOTE

Refer to Reference (a) for policy on boat swimmers. The Auxiliary does not have boat swimmers.

C.4. Knowledge and Performance Skills

To be effective, boat crew members must execute orders quickly and must have the following knowledge and performance skills:

- (01) Marlinspike seamanship and line handling,
- (02) Basic navigation and boat handling,
- (03) Basic use of electronics in cabin (radar, electronic chart systems and global positioning system (GPS)),
- (04) Survival, safety, and damage control equipment,
- (05) Emergency and casualty control,
- (06) Watchstanding and communications,
- (07) First aid.

C.4.a. Boat Specific Information

A keen knowledge of the boat's characteristics and limitations as well as the boat's equipment outfit and stowage plan will be invaluable in times of crisis. Frequent drills practicing the procedures for different emergency circumstances will teach crew members how to react correctly to each situation. All crew members must continuously think about emergency situations and answer the hypothetical question, "What should I do if...?" so that it can be instantly put into action when the question becomes, "What do I do now?"



C.4.b. Knowing the Operating Area

Boat crew members must have knowledge of their local operating area (OPAREA), also called area of responsibility (AOR).

Engineer

C.5. Description

In addition to all of the duties and responsibilities of a boat crew member, engineers are responsible for propulsion and auxiliary machinery while underway. Other responsibilities include the preventive and corrective maintenance performed on the boat in port.

NOTE

There is no engineer position in the Auxiliary program and many other agencies do not require an engineer

C.6. Knowledge and Performance Skills

The knowledge and performance skills required for boat engineers are as extensive as those for coxswains. They must be able to take quick and proper action when faced with any boat engineering casualty. In addition to basic crew member skills, engineers must have the following knowledge and performance skills:

- (01) Demonstrating complete knowledge of general engineering specifications and functional performance characteristics.
- (02) Performing pre-start, light off, and securing functions for propulsion machinery.
- (03) Monitoring, detecting, and responding to machinery and electrical system casualties or failures.
- (04) Operating auxiliary machinery and systems, e.g., pumps, eductors, tillers, etc.

Using onboard damage control equipment to minimize damage from fire, grounding, or collision.



Coxswain/Operator

C.7. Description

Coast Guard boats underway must have a coxswain onboard who is certified by the Unit Commander to operate that particular type of boat. The District Director of Auxiliary certifies Auxiliary coxswains to operate an Auxiliary facility. Other government agencies follow their own certification process for qualification of boat operators. Coxswains are in charge of the boat and crew. The coxswain's duty is unique. The Coast Guard places great trust in the coxswain's ability to provide effective boat crew leadership, team coordination, and risk management.

NOTE

For non Coast Guard agencies, the term coxswain is used extensively throughout this handbook, when you see coxswain used in this handbook, substitute your agency specific term such as boat operator/officer, etc.

The extent of the coxswain's responsibility and authority are specified in Reference (i). Coxswains are responsible, in order of priority, for the following:

- (01) Safety and conduct of passengers and crew,
- (02) Safe operation and navigation of the boat,
- (03) Completion of the sortie(s) or mission(s).

Coxswains will respond to the following:

- (04) Hazards to life or property,
 - (05) Violations of laws or regulations (not applicable to auxiliarists),
 - (06) Discrepancies in aids to navigation.
-



C.8. Knowledge and Performance Skills

The knowledge and performance skills required for coxswains are extensive. Coxswains must apply good judgment, intelligence, and initiative. They must make decisions with the safety of their crew and boat in mind. In addition to basic crew member skills, a coxswain must have the following knowledge and performance skills:

- (01) Demonstrating leadership that effectively coordinates, directs, and guides the performance of the boat crew during watches and tasks (e.g., towing, fog navigation, and Person in the Water).
 - (02) Demonstrating correct application of regulations, policy, and guidance delineated by the Unit Commander or higher authority to the circumstances at hand (e.g., safe navigation, safe speed, law enforcement, rendering assistance, and operating in the vicinity of marine mammals).
 - (03) Knowing the boat's limitations in accordance with the boat operator handbook.
 - (04) Navigating and piloting a boat.
 - (05) Knowing the local OPAREA with minimal reference to charts and publications, including:
 - a) Areas prone to shoaling,
 - b) Locations of whale high-use areas,
 - c) Critical habitats,
 - d) National marine sanctuaries, and
 - e) Other marine protected areas within the operational area.
 - (06) Demonstrating boat handling skills to safely and prudently control the movement of a boat while underway.
 - (07) Understanding the principles of risk management and incorporating them into the decision-making process. These principles include detection, identification, evaluation, and mitigation or control risk as part of making decisions (e.g., slow to safe speed in restricted visibility, cast off a tow because the assisted vessel is losing stability, and collision avoidance).
 - (08) Understanding of the applicable forces acting on the boat and the boat operating characteristics.
-



Section D. Boat Crewmember Responsibilities

Introduction Under the direction of the coxswain, crew members are assigned various watches which are described in this Section

In this Section This Section contains the following information:

Title	See Page
Lookout Watch	2-10
Night Lookout Watch	2-18
Helmsman	2-22
Anchor Watch	2-22
Towing Watch	2-24

Lookout Watch

D.1. Description Navigation Rules & Regulations Handbook states that “Every vessel shall at all times maintain a proper look-out by sight and hearing as well as by all available means appropriate in the prevailing circumstances and conditions, so as to make a full appraisal of the situation and of the risk of collision.”

NOTE 

The coxswain will assign a lookout. If not specifically assigned the duty of lookout, the entire crew must perform lookout duties unless directed otherwise.

D.2. Assign and Station Coxswains shall assign and station lookouts properly to comply with the requirement noted above. Lookouts must report to the coxswain everything seen, smelled, or heard as well as everything they think they see, smell, or hear. **If in doubt, report it!** A sharp lookout is often the first means of protection for the boat to avoid trouble, not to mention locating situations to investigate (e.g., vessels/people in distress, law enforcement, or pollution). Some examples are:

- (01) Vessels,
- (02) Land,
- (03) Obstructions,
- (04) Lights,
- (05) Buoys,
- (06) Beacons,
- (07) Discolored Water,
- (08) Reefs,
- (09) Fog signals,
- (10) Whales,
- (11) Sea Turtles.



NOTE 

It is most important for the coxswain to consider the experience level and abilities of individual crewmembers when making assignments. In the past, the inappropriate assignment of crew duties has contributed to mishaps resulting in fatalities.

NOTE 

More in-depth information on lookout duties and responsibilities can be found in References (j) and (l).

D.3. Guidelines

The following guidelines must be used to stand a proper lookout watch:

- (01) Remain alert and give full attention to the assigned duty.
- (02) Remain at station until relieved.
- (03) Do not distract others with excessive conversation. (However, some conversation among crewmembers may be beneficial in reducing fatigue and maintaining alertness.)
- (04) Speak loudly and distinctly when making a report.
- (05) If the object sighted, smelled or heard cannot be positively identified, report what is believed at that moment.
- (06) Repeat report until it is acknowledged by the coxswain.
- (07) When conditions impair ability to see, smell, or hear; report the condition so the coxswain can take corrective action.
- (08) Report everything seen including floating material, even if it has to be reported several times.

Make sure duties are understood. If duties are not understood, ask for more information.



D.4. Lookout Positioning

Lookouts must be posted by the coxswain so they have the best possible chance of seeing and hearing an approaching vessel or searching for an object in the water. The coxswain should perform the following procedures when positioning lookouts:

Step	Procedure
1	Choose a boat speed that enables lookouts to effectively and safely perform their duties.
2	Position lookouts so they can effectively and safely perform their duties under the operating conditions (e.g., restricted visibility, boat speed, sea state, weather).
3	During periods of rain, sleet, and snow or when taking spray over the bow, select lookout positions that minimize impairment of vision.
4	During a search, post two lookouts when able. Lookouts should be positioned on each side of the vessel so that each can scan a sector from dead ahead to directly aft.
5	Select a stable location that will not place the lookouts in danger of being blown or swept overboard.
6	Duties other than lookout should be kept to a minimum, but especially when whales or other marine mammals are spotted in the area or the boat is within 3 NM of shore.



D.5. Lookout Equipment

Standing a proper lookout watch means using all available equipment to improve chance of early detection. These items include binoculars, sunglasses, and night vision devices (if equipped).

Binoculars are the lookout's best tool to increase their distance vision capabilities. They are very good for identifying contacts far off and obtaining detailed information when they get closer. While they do increase the distance the eye can see, they also reduce a person's field of vision or how much the eye can see. It is important to remember to switch between using binoculars and just eyes to make sure nothing goes unnoticed.

On a sunny day, a large portion of the horizon might be difficult to observe due to the sun's reflection on the surface of the water. A good pair of sunglasses will reduce eyestrain and glare allowing vision where normally it would be difficult.

The use of night vision equipment increases the chance of detecting objects in the dark. This equipment easily detects even the faintest source of light.

They can also be very useful when looking for an unlit object if there is sufficient background lighting. Care should be taken when using this equipment, since pointing it at a bright light might diminish night vision and damage the equipment. Most night vision equipment provides a single color (usually green) image. The single color will reduce depth perception and make distance estimation more difficult.

Thermal imaging devices, where available, can be used in cases where there is no light at all. They can be of particular use when searching for persons in the water (PIW) when arriving on scene prior to commencing a search pattern as well as during an active search. Night vision may be compromised if the monitor's display brilliance is set too high.

D.6. Object Identification

Lookouts must report what they see, smell, or hear with as much detail as possible. Object type is immediately important (vessel, buoy, breaking waves), but additional details may help the coxswain in decision-making. The following are some obvious characteristics of objects:

- (01) Color,
- (02) Shape,
- (03) Size.

At night, lookouts must identify the color of all lights. This is the specific reason that all boat crew members must have normal color vision.

NOTE

Marine mammals and sea turtles can be difficult to detect. Look for these clues: blows, spouts, dorsal fins, heads, splashes, turtle shells, and flukes.



D.7. Relative Bearings

Lookouts make reports using relative bearings only. The relative bearing of another object depends on its location in relation to the vessel's hull. They start off with 000°, which is straight off the bow or dead ahead. The bearings increase moving clockwise around the vessel all the way to 359°. Straight out from the starboard beam of the vessel would be 090°, dead astern would be 180°, and straight out from the port beam of the vessel would be 270° (**Figure 2-1**).

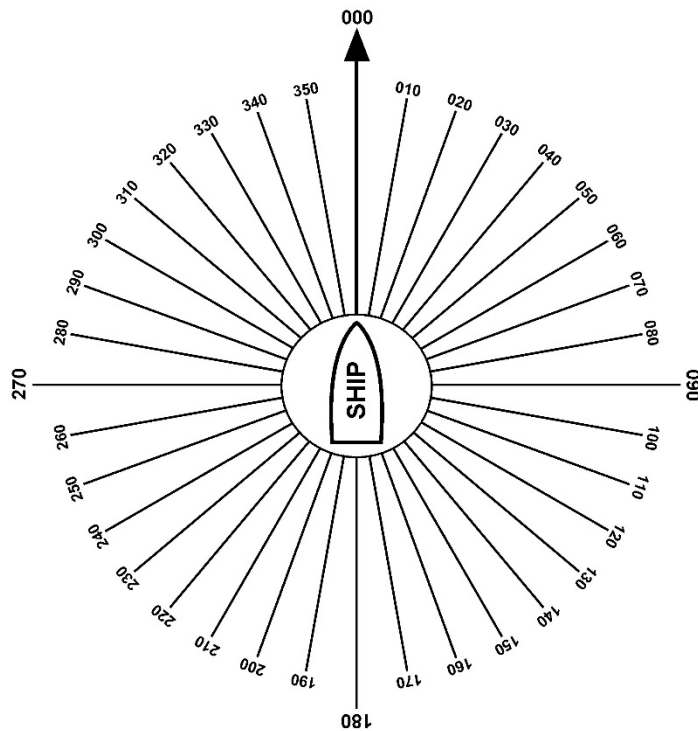

Figure 2-1
Relative Bearings



D.8. Reporting Procedures

The following procedures are important in reporting relative bearings:

Step	Procedure																								
1	Study the diagram on major reference points of relative bearings. Picture in your mind the complete circle of relative bearings around the boat in 10° increments.																								
2	<p>Bearings are always reported in three digits and distinctly spoken digit by digit. To ensure one number is not mistaken for another, the following pronunciation is required:</p> <table border="1" style="margin-left: auto; margin-right: auto;"> <thead> <tr> <th colspan="2">Numeral spoken as</th> <th colspan="2">Numeral spoken as</th> </tr> </thead> <tbody> <tr> <td>0</td> <td><u>Z</u>E-ROH</td> <td>5</td> <td>FIFE</td> </tr> <tr> <td>1</td> <td>WUN</td> <td>6</td> <td>SIX</td> </tr> <tr> <td>2</td> <td>TOO</td> <td>7</td> <td><u>S</u>EV-UN</td> </tr> <tr> <td>3</td> <td>TREE</td> <td>8</td> <td>AIT</td> </tr> <tr> <td>4</td> <td><u>F</u>OW-ER</td> <td>9</td> <td><u>N</u>INE-ER</td> </tr> </tbody> </table>	Numeral spoken as		Numeral spoken as		0	<u>Z</u> E-ROH	5	FIFE	1	WUN	6	SIX	2	TOO	7	<u>S</u> EV-UN	3	TREE	8	AIT	4	<u>F</u> OW-ER	9	<u>N</u> INE-ER
Numeral spoken as		Numeral spoken as																							
0	<u>Z</u> E-ROH	5	FIFE																						
1	WUN	6	SIX																						
2	TOO	7	<u>S</u> EV-UN																						
3	TREE	8	AIT																						
4	<u>F</u> OW-ER	9	<u>N</u> INE-ER																						
3	<p>The following procedures are important in reporting relative bearings:</p> <table border="1" style="margin-left: auto; margin-right: auto;"> <thead> <tr> <th>Bearing</th> <th>Reported as</th> </tr> </thead> <tbody> <tr> <td>000°</td> <td><u>Z</u>E-ROH <u>Z</u>E-ROH <u>Z</u>E-ROH</td> </tr> <tr> <td>010°</td> <td><u>Z</u>E-ROH WUN <u>Z</u>E-ROH</td> </tr> <tr> <td>045°</td> <td><u>Z</u>E-ROH <u>F</u>OW-ER FIFE</td> </tr> <tr> <td>090°</td> <td><u>Z</u>E-ROH <u>N</u>INE-ER <u>Z</u>E-ROH</td> </tr> <tr> <td>135°</td> <td>WUN TREE FIFE</td> </tr> <tr> <td>180°</td> <td>WUN AIT <u>Z</u>E-ROH</td> </tr> <tr> <td>225°</td> <td>TOO TOO FIFE</td> </tr> <tr> <td>260°</td> <td>TOO SIX <u>Z</u>E-ROH</td> </tr> <tr> <td>270°</td> <td>TOO <u>S</u>EV-UN <u>Z</u>E-ROH</td> </tr> <tr> <td>315°</td> <td>TREE WUN FIFE</td> </tr> </tbody> </table>	Bearing	Reported as	000°	<u>Z</u> E-ROH <u>Z</u> E-ROH <u>Z</u> E-ROH	010°	<u>Z</u> E-ROH WUN <u>Z</u> E-ROH	045°	<u>Z</u> E-ROH <u>F</u> OW-ER FIFE	090°	<u>Z</u> E-ROH <u>N</u> INE-ER <u>Z</u> E-ROH	135°	WUN TREE FIFE	180°	WUN AIT <u>Z</u> E-ROH	225°	TOO TOO FIFE	260°	TOO SIX <u>Z</u> E-ROH	270°	TOO <u>S</u> EV-UN <u>Z</u> E-ROH	315°	TREE WUN FIFE		
Bearing	Reported as																								
000°	<u>Z</u> E-ROH <u>Z</u> E-ROH <u>Z</u> E-ROH																								
010°	<u>Z</u> E-ROH WUN <u>Z</u> E-ROH																								
045°	<u>Z</u> E-ROH <u>F</u> OW-ER FIFE																								
090°	<u>Z</u> E-ROH <u>N</u> INE-ER <u>Z</u> E-ROH																								
135°	WUN TREE FIFE																								
180°	WUN AIT <u>Z</u> E-ROH																								
225°	TOO TOO FIFE																								
260°	TOO SIX <u>Z</u> E-ROH																								
270°	TOO <u>S</u> EV-UN <u>Z</u> E-ROH																								
315°	TREE WUN FIFE																								



D.9. Position Angle

Objects in the sky are located by their relative bearing and position angle. The position angle of an aircraft is its height in degrees above the horizon as seen from the boat. The horizon is 0° and directly overhead is 90° or “Zenith.” The position angle can never be more than 90°. Position angles are reported in one or two digits and the word “Position Angle” is always spoken before the numerals (**Figure 2-2**).

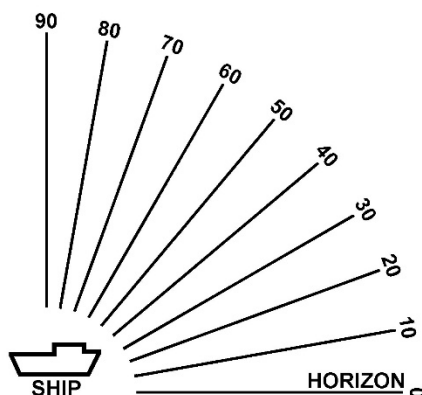

Figure 2-2
Position Angles

D.10. Distance

Report distances in yards. Knowing the distance to the horizon, land, or other reference point, will help estimate distance. Dividing the distance from the starting point to the point of reference, provides an estimate of the distance to another object. Ranges in yards are reported digit by digit, except when reporting yards in hundreds or thousands, which are spoken as listed below:

Number of Yards	Spoken as
50	FIFE <u>ZE</u> -ROH
500	FIFE HUNDRED
5000	FIFE THOUSAND

D.11. Making Reports

When making reports, the lookout names or provides a description of the object sighted, the direction (in relative degrees), the position angle (if an air contact), and the range to the object (in yards) are required and must be reported in the following format:

- (01) Object name or description.
- (02) Bearing.
- (03) Position Angle (air contact only).



(04) Range.

For example:

Discolored water on a bearing of 340° relative to the bow of the boat and at a distance of 2,000 yards.

Reported as: “Discolored water Bearing TREE- FOW-ER ZE-ROH, Range TOO THOUSAND”.

An aircraft bearing 280° relative to the bow of the ship, 30° above the horizon, and at a distance of 9,000 yards.

Reported as: “Aircraft Bearing TOO AIT ZE-ROH, Position Angle TREE ZE-ROH, Range NINE-ER THOUSAND”.

D.12. Scanning

The lookout’s method of eye search is called scanning. Scanning is a step-by-step method of visually searching for objects. Good scanning techniques will ensure that objects are not missed. Scanning also reduces eye fatigue. Development of a systematic scanning technique is important. There are two common scanning methods:

- (01) Left to right and back again.
- (02) Top to bottom and bottom to top.

In either case, move eyes in increments. This creates overlaps in field of vision and fewer objects will be missed.

Step	Procedure
1	When looking for an object, scan the sky, sea, and horizon slowly and regularly. Scan from left-to-right and back again or from top-to-bottom and bottom-to-top.
2	When scanning, do not look directly at the horizon; look above it. Move head from side to side and keep eyes fixed. This will give any stationary objects in the field of vision the appearance of moving and make them easier to see. One technique is to scan in small steps of about 10° and have them slightly overlap while moving across the field of view.
3	Fatigue, boredom, and environmental conditions affect scanning. For example, after prolonged scanning, with little or no contrast, the eyes develop a tendency to focus short of where the person is looking. To prevent this, periodically focus on a close object such as whitecaps or the bow of the boat.

NOTE

For more details on scanning, refer to Reference (1).



D.13. Fog Scanning

Early detection in fog is vital because a contact might be heard long before it's seen. Early detection is vital. Since the fog reduces visual distance, binoculars are not recommended. It is better to have a wide field of vision than a narrow magnified one. It is also important to position the lookout where they will not be hindered by background noise and other distractions. Usually the bow is best, if conditions allow. In severe fog, a second designated lookout should be stationed to cover the aft portion of the vessel.

Designated lookout should make use of all available equipment, including thermal imaging devices, which will assist in the assignment.

Night Lookout Watch

D.14. Description Although the duties for day and night lookout are the same, safety and caution during night watches are especially important. Though it might be easier to acquire a contact on the horizon at night because of its navigation lights, it's obviously more difficult to pick up unlighted objects such as rocks, shoals, and buoys. Eyes respond more slowly at night and have a harder time picking up fixed objects than moving objects.

D.15. Guidelines The guidelines for lookout watches also apply for night lookout watches.

D.16. Dark Adaptation Going from a brightly lit room to a very dark room initially decreases vision. As time in the darkness increases, vision improves and things that were not visible on the initial point of entry are now clear. As eyes adjust to the weak light, vision gradually improves. This is called dark adaptation. Before operating in dark conditions, it is recommended to prepare by moving into a dark environment or wearing goggles equipped with red lenses for 30 minutes prior to getting underway. Care should be taken not to expose eyes to bright lights once they are adjusted. Even a quick flash of light can destroy night vision. Chart and cabin lights, as well as flashlights, should be equipped with red filters to ensure night vision is maintained while underway.

NOTE *RS*

Avoid looking at bright lights during nighttime operations. When a light must be used, use a red light. Avoid using flash cameras or mobile phones with flash capabilities.



D.17. Night Scanning

As a night lookout, scan the horizon in a series of small sectors allowing eyes to adjust to each. When looking at an object, look all around it, not directly at it. This “off-center vision” allows the object to be seen clearer than trying to stare directly at it. Once located, use binoculars to assist with identification. The use of electronic night vision equipment is highly recommended for early detection.

D.18. Night Fog

In night time fog conditions, any source of light (navigation lights) will reflect back off the fog and reduce night vision. This effect will reduce the lookout’s ability to detect contacts in various sectors surrounding the boat. Extra care should be used when operating at night in the fog. The use of spotlights is not recommended unless identifying objects that are within close range.

D.19. Night Vision Devices (AN/PVS-14 MNVD)

The AN/PVS-14 Monocular Night Vision Device (MNVD) is the current Coast Guard-issued nighttime detection equipment available to our boat community. Night vision devices improve the user’s visual acuity while operating in environments with negligible ambient lighting. The AN/PVS-14 is the all around best multi functional night vision monocular available to our multi-mission platforms.

The image area viewed through night vision devices is most pronounced under low light conditions. Seeing it is an indicator that supplemental illumination is needed. Under most conditions, an infrared (IR) light source is preferable to a visible light source and may be provided by a flashlight with an IR filter, handheld IR illuminators and spotlights, IR chemlights, etc. Crews should employ supplemental IR illumination to the maximum extent possible, especially if search targets may be wearing highly reflective material, such as the reflective tape of a PFD.

NOTE 

When using night vision, the eye adjusts to the light output of the eyepiece. When removed, the vision will be limited in the eye that was night-vision aided. It will normally take at least two minutes to regain total, unaided dark-adapted vision.

NOTE 

Use extreme caution when considering the use of an IR light source as it will indicate your position to anyone else using night vision devices.

Night vision devices provide a 40 degree field of view, which is substantially less than the normal peripheral vision of 190 degrees. This means that when you're wearing the night vision device, you're unable to see things to your far left or right, or above or below, the direction you're looking. Use of monocular devices rather than binocular systems help, as vision in one eye is less affected and you do not lose peripheral vision on the side of the unaided eye. Regardless the system in use, it is critical to constantly scan to maintain awareness of the surroundings.



Because night vision provides the eye a flat two-dimensional picture tube (called a phosphor screen), depth perception will be affected. Time spent training with the equipment will help the brain compensate for this. Night vision devices cannot see the colors normally seen. Because night vision devices are more sensitive to red and white lights, they will appear brighter and sometimes closer. For this reason, the apparent brightness of a light should not be used as an estimate for the distance to the light. A halo may be visible around some lights and obscure the area around the light source. Reducing brightness on variable gain equipped units may reduce the halo.

Image intensification is not designed to see through fog, smoke, heavy rain, or snowfall, which reflect ambient light. Using supplemental IR illumination will only make it more difficult to see.

NOTE 

Additional information can be found in Commandant Instruction 1543.3, Personnel Qualification Standard (PQS) – AN/PVS 14 Monocular Night Vision Device (MNVD).

D.20. Thermal Imaging Devices

A thermal imaging device can aid in the safe navigation of a boat. When used properly, a thermal imaging device can not only increase mission safety but also mission success by displaying an electronic image of an object's heat signature.

A thermal imaging device can enhance visibility, allowing an experienced boat crew to identify hazards along their course such as unlit buoys or day beacons as well as poorly or unlit vessels.. Even with the advantage of a thermal imaging device, crews should always maintain a safe speed to avoid collisions.

D.20.a. Basic Operating Principle

Infrared radiation is emitted from every object, even ice. A thermal imaging device uses specialized sensors to capture and display the “heat energy” on a monitor which allows a user to view the differences of infrared radiation emitted from objects in the camera view.

The thermal imaging device does not measure how much heat is in an object; rather it is showing the amount of heat an object emits, relative to other objects in view. The clarity of the displayed image is a function of the settings used, when compared to other objects, the picture of what you are viewing is usually quite clear. For example, a person in the water emits more heat than the water.



D.20.b. Display Options

Most thermal imaging devices have several types of image displays. The two most common types of image displays are:

- (01) White Hot – Images reflecting more heat are white,
- (02) Black Hot – Images reflecting more heat are black.



Figure 2-3
White Hot Thermal Display



Figure 2-4
Black Hot Thermal Display

D.20.c. No Light Environments

Thermal imaging devices differ from night vision devices because night vision devices amplify the light available to increase visibility, whereas, a thermal imaging device detects infrared radiation emitted from objects and requires no light. This is a distinct advantage when underway and there is no light.

D.20.d Range

The range of a thermal imaging device is limited, much like a camera. It will not take pictures around the corner, it will not take pictures “through” items and it will not show items beyond the horizon. It is line of sight only. Even if a contact can be seen 5 miles away, the image on the screen may not show that contact with much detail, if at all. Understanding this limitation is essential.

D.20.e Weather

The image displayed can be affected by the weather. Most times there is sufficient contrast between the different objects on the screen, however, there are times when due to certain environmental factors, the image contrast isn’t as clear. This can occur in the early morning or when it has been a foggy day. This is because objects have not had a chance to absorb the sun’s energy throughout the day and radiate the heat energy back into the atmosphere (this is what shows the differences on the screen). The picture will still show objects but the differences in color may be subtle. Frequent exposure and training to these subtle differences allow a crew to interpret these images.

Additionally, while you can see the heat energy of objects in the fog, it does limit the range in which you are able to see.



Helmsman

D.21. Description The helmsman is responsible for the following:

- (01) Safely steering the boat.
- (02) Maintaining a course.
- (03) Carrying out all helm commands given by the coxswain.

The helmsman role can be carried out by the coxswain or by any designated crew member. Every crew member should learn to steer and control the boat. They must be able to maneuver the boat using both the primary and emergency steering systems (if equipped) as well as the engine(s).

D.22. Guidelines There are several guidelines when a boat uses a helmsman:

- (01) Check with the coxswain for any special instructions and for the course to be steered.
 - (02) Repeat all commands given by the coxswain.
 - (03) Execute all commands given by the coxswain.
 - (04) Maintain a given course within $\pm 5^\circ$ of ordered course.
 - (05) Remain at the helm until properly relieved.
 - (06) Execute maneuvers only when expressly ordered, however, minor changes in heading to avoid debris, which could damage propeller or rudders, are essential.
 - (07) Operate the emergency tiller (if equipped) during loss of steering.
 - (08) Properly inform relief of all pertinent information.
-

Anchor Watch

D.23. Description An anchor watch is set when the boat is at anchor. The person on watch must ensure that the anchor line does not chafe and that the anchor does not drag. The individual on watch also looks for other vessels in the area. Even when the boat is anchored, there is the possibility that it can be hit by another boat. For more information on anchoring procedures, see Reference (k).



D.24. Guidelines The following guidelines should be used when standing anchor watch:

- (01) Check the strain on the anchor line frequently.
- (02) Check that the anchor line is not chafing.
- (03) Confirm the position of the boat at least every 15 minutes, or at shorter intervals as directed by the coxswain.
- (04) Report bearing or range (distance) changes to the coxswain immediately.
- (05) Report approaching vessels to the coxswain immediately.
- (06) Report major changes in wind velocity or direction.
- (07) Check for current or tidal changes.
- (08) Report any unusual conditions.

D.25. Checking for Chafing Once the anchor is set, chafing gear should be applied to the anchor line. It is the job of the anchor watch to ensure chafing gear stays in place and the anchor line does not chafe through.

D.26. Checking for Dragging There are two methods to determine if the anchor is dragging:

- (01) Check for tension on the anchor line.
- (02) Check the boat's position.

If the anchor is dragging over the bottom, sometimes vibration can be felt in the line. The boat's position should be periodically checked by taking a navigational fix. Both methods above should always be used.

D.27. Checking Position It is important to routinely check the boat's position to ensure it is not drifting or dragging anchor:

- (01) On a GPS equipped boat, note the boat's position or set the anchor alarm, if equipped. Any change in position or audible alarm would indicate the boat's position is changing.
- (02) On a boat equipped with radar, determine the distance (range) to three points of land on the radar screen. Any change in the ranges may indicate anchor drag.
- (03) Take compass bearings to three separate objects spread at least 45° apart. Any bearing changes may indicate that the boat is beginning to drift.
- (04) Make a note of each time the bearings or ranges are checked. Also note the boat's position and the depth of water regularly. If the water depth or position changes, the anchor may be dragging.



As the wind or water current changes direction, the boat will swing about its anchor. This swing circle is centered on the position of the anchor. The swing circle's radius is equal to the boat's length plus the length of anchor line/chain that has veered (Example: 40-foot boat + 150 feet of anchor line out = 190-foot swing circle). The swing circle must be clear of other vessels and underwater obstructions. When checking the boat's position, it should fall inside the swing circle.

Towing Watch

D.28. Towing Watch

A towing watch is normally performed aft on the boat. The primary duty of the towing watch is to keep the towline and the boat being towed under constant observation.

D.29. Tow Watch Guidelines

The guidelines for standing this watch are as follows:

- (01) Report any unusual conditions, equipment failure, or problems to the coxswain immediately.
 - (02) Observe how the tow is riding (e.g., in step, listing, or yawing).
 - (03) Ensure chafing gear is riding in place.
 - (04) Adjust the scope of the towline upon command of the coxswain.
 - (05) Keep deck space area clear of unnecessary gear and people.
 - (06) Stay clear of the immediate area around the towline due to possible line snap back.
 - (07) Know when and how to do an emergency breakaway.
-

D.30. Observed Danger

The towing watch must be aware of and report any signs of danger. Many of the signs of danger include:

- (01) Yawing - disabled boat veers from one side to the other which may cause one or both boats to capsize.
 - (02) List increasing on towed boat.
 - (03) Boats out of step – When both boats are not on the crest or in the trough of the seas at the same time potentially causing undo strain on the towline.
 - (04) Towed boat taking on water.
 - (05) Deck hardware failure due to stress, no backing plates, etc.
 - (06) Towline about to part due to stress, chafing, or other damage.
 - (07) Towed boat overtaking boat due to sudden reduction in speed.
 - (08) Positioning of towed boat's crew/waving of arms.
 - (09) Slack tow line in the water that may foul propeller, rudder or waterjets.
-



**D.31. Maintaining
Watch**

A tow watch should be maintained until the disabled boat is moored or until relieved. When relieved, all important information should be passed to the relief (e.g., problems with chafing gear, towed boat yaws, etc.).



Section E. Crew Fatigue

Introduction

The crew's physiological well-being plays an important role in the safe and successful accomplishment of each mission. A crewmember will assist people during the worst conditions. At times, they may feel like they have reached the limits of their physical and mental endurance.

In this Section

This Section contains the following information:

Title	See Page
Fatigue	2-26
Crew Responsibility	2-27
Symptoms	2-27
Prevention	2-27
Environmental Conditions	2-28

E.1. Fatigue

Mental and physical fatigues are among the greatest dangers during rough weather operations. The hazard of fatigue dramatically reduces the powers of observation, concentration, and judgment. This reduces the ability to exert effort and increases the probability that prescribed safety precautions may be disregarded. The following are examples of situations that may cause fatigue:

- (01) Operating in extreme hot or cold weather conditions.
 - (02) Eye strain from hours of looking through sea-spray blurred windshields.
 - (03) The effort of holding on and maintaining balance.
 - (04) Stress.
 - (05) Exposure to noise.
 - (06) Exposure to the sun.
 - (07) Poor physical conditioning.
 - (08) Lack of sleep.
 - (09) Boredom.
-



E.2. Crew Responsibility

The crew's safety and welfare are the coxswain's primary responsibility. Coxswains must be constantly aware of stress signs evident in their crews, learn to recognize fatigue, and take corrective action. Crewmembers must watch each other's condition to prevent excessive fatigue from taking its toll. The ability of each member to respond to normal conversation and to complete routine tasks should be observed.

E.3. Symptoms

The primary symptoms of fatigue are:

- (01) Inability to focus or concentrate/narrowed attention span.
- (02) Mental confusion or judgment error.
- (03) Decreased coordination of motor skills and sensory ability (hearing, seeing).
- (04) Increased irritability.
- (05) Decreased performance.
- (06) Decreased concern for safety.

Any one of these symptoms can cause mistakes in judgment or cause taking shortcuts that could threaten the safety of the mission and crew. It is important to ward off the effects of fatigue before it gets too great. Fatigue can lead to faulty decisions and a "don't care" type of attitude.

E.4. Prevention

Coxswains must be aware of the dangers that exist when crewmembers push themselves beyond reasonable limits of performance. They should help eliminate mistakes caused by fatigue. Coxswains must not hesitate to call for assistance when fatigue begins to impair the efficiency of their crew.

Some preventive measures are:

- (01) Adequate rest.
 - (02) Appropriate dress for weather conditions.
 - (03) Rotating crew duties.
 - (04) Providing food and refreshments suitable for conditions.
 - (05) Observing other crewmembers for signs of fatigue.
-



E.5. Environmental Conditions

Despite the normal operating climate in a particular area, all crewmembers must dress for the prevailing weather. Keeping warm in cold weather and cool in hot weather helps prevent fatigue. Some other environmental conditions that also promote fatigue are:

- (01) Motion sickness,
- (02) Glare from the sun,
- (03) Wind and rough sea conditions,
- (04) Fog, Rain or snow,
- (05) Vibration and sound (boat engine).

NOTE

Information on Boat Crew Fatigue Standards may be found in Reference (a).



Section F. Drugs and Alcohol

Introduction Alcohol and drug use causes slower reaction time, lack of coordination, slurred speech, drowsiness, and/or an overconfident attitude. Hangovers also cause irritability, drowsiness, sea-sickness, and a lack of concentration. Crewmembers who knowingly get underway for a mission while under the influence are putting themselves and others at risk.

In this Section

This Section contains the following information:

Title	See Page
Prescription Drugs	2-29
Alcohol	2-29
Tobacco	2-30
Caffeine	2-30

F.1. Prescription Drugs

Prescription drugs have the ability to impair or incapacitate crewmembers. Certain medications can be as incapacitating as alcohol. In addition, many medications, if taken with alcohol, accentuate the action of both. Crewmembers should always notify the command while taking prescription drugs which may affect performance or prevent performance of duties.

F.2. Alcohol

Alcohol is a well recognized central nervous system depressant and is one of the most frequently used and abused drugs in our society. Even small amounts of alcohol in the blood can seriously impair judgment, reaction time, and muscular control, and reduce the restorative effects of sleep.

The level of alcohol in the body varies with the frequency and amount of alcohol intake, the length of time following cessation of drinking and an individual's body weight. A zero alcohol level is essential for boat crew personnel to meet the rigorous demands of boat operations.

Detectable blood alcohol or symptomatic hangovers are usually causes for restricting boat crew personnel from operations. Personnel in a duty status shall not consume alcohol for a minimum 12 hours prior to assuming duty. This time span allows an adequate margin of safety before resuming operations.



F.3. Tobacco

The nicotine contained in tobacco is a quick-acting poison. Excessive smoking causes depression of the nervous system and impairment of vision. The carbon monoxide resulting from the combustion of tobacco is absorbed by the bloodstream in preference to oxygen, resulting in a lowering of altitude tolerance. Tobacco smoke also irritates the respiratory system.

F.4. Caffeine

The drug caffeine, contained in coffee, energy drinks, tea, and many soft drinks, can produce an adverse effect on the body. The amount of caffeine contained in just two cups of coffee or one energy drink appreciably affects the rates of blood-flow and respiration. In small amounts, coffee and energy drinks can be considered nervous system stimulants. Excessive amounts may produce nervousness, inability to concentrate, headaches, and dizziness. Individuals accustomed to daily intake of caffeine may develop headaches and experience a loss of sharpness if daily intake is stopped or significantly curtailed.



CHAPTER 3

Towing

Introduction As a boat crewmember, towing will be one of the missions executed for many types of maritime craft. This chapter covers forces in towing, towing equipment, safety, and procedures. Boat crews need a firm grasp of towing principles to ensure that an evolution does not result in injury, death or further damage to property. No two towing evolutions are exactly the same. Towing should never be considered “routine.” Variations in technique and procedures will occur. Knowledge of principles and standard procedures should be applied to account for weather and sea conditions, vessel types, and crew experience. The tow should always be within the crew’s and vessel’s capabilities.

Every boat crewmember is responsible for identifying and managing risks associated with towing. Operational mishaps can be prevented by honestly evaluating risks involved in every step of any evolution. Effective communication during all missions is essential to a successful mission completion. Refer to Reference (h) for additional risk management policy information.

This Chapter outlines operational doctrine and basic techniques commonly used by boats in support of boat operations.

In this Chapter This Chapter contains the following Sections:

Section	Title	See Page
A	Towing Forces	3-2
B	Towing Equipment	3-13
C	Standard Towing Procedures	3-30
D	Towing in Heavy Weather	3-77



Section A. Towing Forces

Introduction Reference (j) states policy on vessel-assistance towing. Specific Boat Operator's Handbooks provide specific procedures for those types of boats. Individual manufacturers' boat owner's guides and product specification sheets provide equipment limitations and safety information for OGAs. Reference (b) addresses crew performance requirements. **Towing Watch** outlines the towing watch responsibilities. Boat crews should be familiar with and comply with the policies, direction and information in these sources.

In this Section This Section contains the following topics:

Title	See Page
Towing Forces	3-3
Dynamic Forces	3-7
Combination of Forces and Shock-Load	3-10



Towing Forces

A.1. Towing Safety

Safety is always the most important concern when towing. Every towing activity is potentially dangerous. The safety of the crew and the crew of the towed vessel is more important than property, and the primary responsibility in any towing situation is to maintain safety. Towing is a complex evolution. A safe and successful outcome hinges on crew professionalism, ability, and teamwork.

A.1.a Risk Assessment

Every boat crewmember is responsible for identifying and managing risks. Towing mishaps can be prevented by honestly evaluating risks involved in every step of any towing evolution. Communicating with the towed vessel's crew may provide important information necessary to complete a successful mission is essential and help make a risk assessment.

WARNING

Do not let a perceived need to engage in a towing mission override a complete, honest risk assessment process that emphasizes personnel safety.

A.1.b Situational Awareness

The dynamics of a towing situation continuously change from the time pre-towing preparations begin until mooring at the conclusion of the mission. All crewmembers must stay fully aware of the constantly changing situation at any given time during a towing evolution. It is important that each crewmember knows what goes on in the surrounding environment and how things change. Crew awareness should be reinforced through communication: commenting on what is believed to be happening and involving the towed vessel's crew. The "outside" view could provide information on things not visible from the towing vessel.

When clues indicate that situational awareness is being lost, a decision must be made whether or not to continue with the towing evolution. A decision takes the form of action/reaction and communication. Everyone in the crew has a responsibility in the decision-making process.

A.1.c Risk Management Planning

Realistic towing training based on standardized techniques, critical analysis, and mission briefing and debriefing will contribute to risk management and the development of a towing risk management plan. All crewmembers must contribute to risk management planning.



A.2. Towing Forces

Boat crews must understand the forces, or types of resistance, which act on the towed vessel and how to handle the resistance safely. They are the same forces that affect all vessels, but a distressed vessel is limited in how it can overcome them. The towing vessel must provide the means to move the towed vessel. The towline or tow rig transfers all forces between the two vessels. Boat crews must learn to recognize the different forces and each of their effects individually to effectively balance and overcome them when they act together.

A.2. a. Static Forces

Static forces cause a towed vessel to resist motion. The displacement or mass of a towed vessel determines the amount of force working against the vessel. The assisting vessel must overcome these forces before the towed vessel moves. Inertia and the moment of inertia are two different properties of static forces that cause resistance in towing vessels.

A.2.a.1. Inertia

In this case, inertia is the tendency for a vessel at rest to stay at rest. The more mass a vessel has (the greater its displacement), the harder it is to get it moving.



A.2.b. Moment of Inertia

The moment of inertia occurs when a towed vessel resists effort to turn about a vertical axis to change heading. The larger the vessel, the more resistance there will be in turning the vessel. Unless necessary in a case of immediate danger, an attempt to tow a distressed vessel ahead and change its heading at the same time should not be used (see **Figure 3-1**). Both inertia and the moment of inertia will be involved in the resistance of moving the distressed vessel, which can cause potentially dangerous situations and greater resistance for towing. Both of the vessels, as well as their fittings and the towing equipment, take much less stress and strain when the two forces are conquered individually.

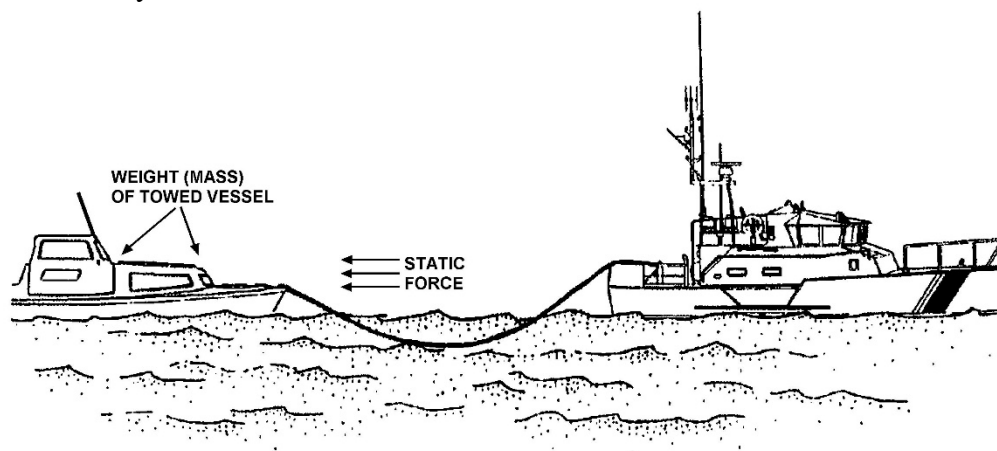

Figure 3-1
Static Forces

Overcome the effects of static forces by starting a tow slowly, both on the initial heading or when changing the towed vessel's heading. A large amount of strain is placed on both of the vessels, as well as their fittings and the towing equipment, when going from dead-in-the-water to moving in the desired direction and at the desired speed. Extreme caution should be used when towing a vessel of equal or greater mass than the assisting vessel. In such situations, the assisting vessel strains the capacity and capability of its equipment, requiring slow and gradual changes.



A.2.c. Starting
the Tow on the
Initial Heading

To start the tow on the initial heading, perform the following procedures:

Step	Procedure
1	Apply the towing force on the initial heading to gradually overcome the towed vessel's inertia.
2	As the towed vessel gains momentum, slowly and gradually increase speed.
3	To change the tow direction, make any change slowly and gradually after the towed vessel is moving.

A.2.d. Changing
the Towed
Vessel's Heading

To change the towed vessel's heading, perform the following procedures:

Step	Procedure
1	Apply the towing force perpendicular to the vessel's heading. Once the towed vessel starts to turn, resistance will develop.
2	Apply turning force slowly and gradually. It is more difficult to change the initial heading of a heavy vessel (one with a high moment of inertia) than a light one.
3	Now, begin to tow in the desired direction and gradually overcome inertia to get the towed vessel moving forward.
4	Once making way, the effects of static forces lessen.
5	Until the tow achieves a steady speed and direction, apply power or turning force to defeat any remaining inertia or to change the towed vessel's momentum gradually.



Dynamic Forces

A.3. Dynamic Forces

Dynamic forces occur once the towed vessel is moving. They are based on the towed vessel's characteristics (shape, displacement, arrangement, rigging), the motion caused by the towing vessel, and the effects of waves and wind (see [Figure 3-2](#)).

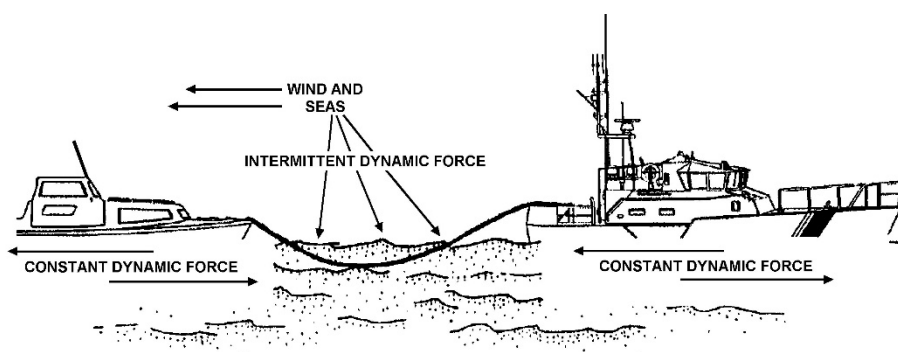

Figure 3-2
Dynamic Forces

A.4. Momentum

Once a vessel moves in a straight line, it wants to keep moving in a straight line. The greater its displacement or the faster it is moving, the harder it is to stop or change the vessel's direction.

A.5. Angular Momentum

Once the vessel's heading begins to change, it wants to keep changing in that same direction. The faster the towed vessel's heading changes, the harder it is to get the tow moving in a straight line.

The towed vessel's momentum will gradually increase with towing speed. Momentum in a straight line will resist effort to change the towed vessel's direction and will tend to keep the towed vessel moving when tension in the towing rig is decreased. When changing directions, the towed vessel will develop angular momentum while the vessel's heading is changing. Towing force opposite the swing may need to be applied before the towed vessel achieves the desired heading. The key to dealing with momentum is to anticipate how momentum will affect the towed vessel's motion and apply an offsetting force early and gradually.

A.6. Frictional Resistance

As a vessel moves, the layer of water in immediate contact with the hull moves. Due to friction between water molecules, the layers of water close to the hull try to drag along. The vessel appears to move "through" the water. This attempt to drag water alongside takes energy. As speed increases, this action becomes "turbulent." This turbulence takes additional energy, and more speed requires even more power.



CAUTION!

Frictional resistance will constantly affect the tow, *normally* keeping some steady tension in the towing rig. Since the shape and wetted surface area of the towed vessel will not change, frictional resistance is managed with towing speed. Higher towing speed causes higher frictional resistance and more strain on the towing rig.

NOTE 

Frictional resistance also varies with hull shape. Greater underwater (wetted) surface area causes greater frictional resistance. Hull appendages, such as propellers, shafts, skegs, keel, and rudders contribute to wetted surface area and frictional resistance.

A.7. Form Drag

Form drag plays a large role in the ability to control changes in the towed vessel’s movement. Different hull shapes react to motion through the water in different ways. The shape and size of the towed vessel’s hull can either help or hinder effort to move in a straight line, when changing heading, and motion changes in response to waves due to buoyancy. The less water a hull shape has to push out of its way, the easier it will move through the water. A deep-draft, full-hulled vessel takes more effort to move than one with a fine, shallow hull. A large amount of lateral resistance, spread evenly over the length of the hull, will hinder effort to change a towed vessel’s direction, but will help offset angular momentum in steadying up on a desired heading. A towed vessel may be able to help offset form drag by using its rudder.

CAUTION !

It is not always safe to tow a planing hull type of vessel above planing speed. Going from displacement speed to planing speed, or back, can decrease the towed vessel’s stability and cause it to capsize. Also, wave drag (even one large wake) could slow the hull down to displacement speed and cause a severe “shock-load” as the towed vessel tries to get back on plane.

A.8. Wave-Making Resistance

A surface wave forms at the bow while the hull moves through the water. The size of the bow wave increases as speed increases, causing the wave to create resistance for the bow to be pulled or propelled through the water.

Boat crews should keep in mind the different hull types of maritime craft, including the towing vessel. In any towing evolution, the boat crew must be able to recognize a vessel’s hull type, as well as its critical capabilities and limitations. Dependent on the type of hull, towing vessels must be careful not to tow a vessel faster than the design speed of its hull. Refer to **Table 3-1** on page 3-57 for a discussion of towing speeds.

NOTE 

“Shock-load” or “shock-loading” is the rapid, extreme increase in tension on the towline, which transfers through the tow rig and fittings to both vessels.



A.9. Wave Drag, Spray Drag, and Wind Drag

The frictional forces of wave drag, spray drag, and wind drag act on the hull, topsides, superstructure, and rigging. They all have a major effect on the motion of the towed vessel, and the transfer of forces to and through the towing rig. These constantly changing forces all vary with the towed vessel's motion relative to the environmental elements and are directly related to the towed vessel's exposure to them. These forces can add up and cause shock-loading. Wind and wave drag also cause a distressed drifting vessel to make leeway, which is motion in a downwind direction.

A.9.a. Wave Drag

Wave drag depends on the "normal" wetted surface area of the hull and the amount of freeboard exposed to wave action. Wave drag has a large effect on the strain of the tow rig.

- (01) In large seas, be aware of:
 - a) Combination of wave drag and form drag could overcome the towed vessel's forward momentum and cause the towed vessel to stop and transfer a large amount of strain to the tow rig.
 - b) Shock-load could damage a vessel's fittings and part the towline endangering both vessels' crews.
 - (02) In head seas, be aware of:
 - a) Towing vessel can only control the effect of wave drag by the speed and angle that the towed vessel encounters the waves.
 - b) Limiting speed and towing at an angle to the seas to prevent them from breaking over the bow of the towed vessel.
 - (03) In following seas, be aware of:
 - a) Wave drag causing the towed vessel to speed up as the crest approaches, increasing speed to keep tension in the towing rig, and reducing speed as the crest passes.
-

A.9.b. Spray Drag

Spray drag also provides resistance to the tow. The spray from a wave could slow the towed vessel and increase the amount of shock-loading. Spray drag could also adversely affect the towed vessel's motion by imparting a momentary heel, pooling on deck or in the vessel cockpit, and in cold weather form ice, and thus decrease stability.

A.9.c. Wind Drag

Wind drag can cause shock-loading and have a bad effect on the towed vessel's motions and stability. A steady beam wind can cause list and leeway, while a severe gust can cause a threatening heel. List, heel, and leeway may cause the towed vessel to yaw. A headwind increases tow rig loading in a direct line with the towed vessel while the towed vessel crests a wave, causing shock-loading.



A.10. Buoyancy Response and Gravity Effects

Boat crews should develop a feel for the towed vessel's initial and reserve buoyancy characteristics, overall stability, sea keeping, response to the prevailing environmental conditions, and the response to being towed. Though a distressed vessel may *seem* stable and sound at rest, its response once in tow could be to capsize. A towed vessel's bow may react to an oncoming wave by pitching skyward, or by "submarining." Buoyancy response to following seas could cause the towed vessel to yaw excessively or gravity may cause it to gain speed and "surf" down the face of a wave.

WARNING

Once making way, a vessel's buoyancy response or the effect of gravity in a seaway may cause severe shock loading.

Combination of Forces and Shock-Load

A.11. Combination of Forces and Shock-Load

During a towing evolution, the boat crew rarely deals with only one force acting upon the tow. The crew usually faces a combination of all the forces, each making the situation more complex. Some individual forces are very large and relatively constant. Crews can usually deal with these safely, provided all towing-force changes are made gradually. When forces are changed in an irregular manner, tension on the tow rig starts to vary instead of remaining steady.

A.12. Example

Even in calm winds and seas, a towing vessel can encounter a large amount of frictional resistance from form and wave drag when towing a large fishing vessel with trawl lines fouled in its propeller and net still in the water. The tow rig and vessel fittings will be under heavy strain, and the tow vessel engine loads will be rather high, but the tow proceeds relatively safely. If suddenly the net tangled and caught on an unseen obstacle, this new "force" acting through the tow rig could immediately increase stress to a dangerous level. This shock-load could part the towline or destroy fittings.

(In the example above, the prudent solution would be to make a "safe" tow by recovering the net or marking it and letting it loose before starting the tow.)

Though this example began as a safe and steady tow, a single unexpected incident could have caused a very dangerous situation. Boat crews should always keep in mind that some degree of shock-loading can occur during any tow evolution.

CAUTION !

Shock-loading may cause severe damage to both towing and towed vessels and overload a tow rig to the point of towline or bridle failure. Shock-loading could also cause momentary loss of directional control by either vessel and could capsize small vessels.



A.13. Shock-Loading Prevention or Counteraction

Because of the potential dangers, the tow vessel must use various techniques to prevent or counteract shock-loading, or reduce its effect.

Action	Effect
Reduce Towing Speed	Slowing down lowers frictional resistance, form drag, and wave-making resistance. Reducing these forces will lower the total tow-rig tension. In head seas, reducing speed also reduces wave drag, spray drag, and wind drag, lowering the irregular tow rig loads. The total reduction in forces on the tow could be rather substantial. When encountering vessel wake in relatively calm conditions, decrease speed early enough so the towed vessel loses momentum before hitting the wake. A small towed vessel slamming into a large wake will shock-load the tow rig, and may even swamp the vessel.
Get the Vessels “In-Step”	Extreme stress is put on the tow rig in heavy weather when the tow vessel and the towing vessel do not climb, crest or descend waves together. Vessels in step will gain and lose momentum at the same time, allowing the towing force to gradually overcome the towed vessel’s loss of momentum, minimizing shock-loading. To get the vessels in step, lengthen rather than shorten the towline if possible.
<p>NOTE  When operating near bars and inlets, getting the vessels in step may be impractical due to rapidly changing water depth and bottom contours. Counteracting shock-load may be used when transiting bars and inlets.</p>	
Lengthen the Towline	A longer towline reduces the effect of shock-loading in two ways. The weight of the line causes a dip in the line called a catenary. The more line out, the greater the catenary. When tension increases, energy from shock-loading is spent on “flattening out” the catenary before it is transferred through the rest of the rig and fittings. The second benefit of a longer towline is more stretch length. Depending on the type of towline, another 50' of towline length will give 5'-20' more stretch to act as a shock-load absorber. Remember to lengthen the towline enough to keep the vessels in step and minimize the shock-load source.



Action	Effect
Set a Course to Lessen the Effect of the Seas	Do not try to tow a vessel either directly into or directly down large seas. Tow on a course to keep the seas 30°-45° either side of dead ahead or dead astern. This may require “tacking” to either side of the actual desired course.
Deploy a Drogue from the Towed Vessel	The drogue (covered in Drogues of this chapter) may help to prevent the towed vessel from rapidly accelerating down the face of a wave. The drogue does add form drag to the tow, but could prevent shock-load.
CAUTION!	Shock-load can also capsize or swamp the towed vessel. The additional towing force from a shock-loaded towline could cause a smaller vessel to climb its bow wave and become unstable or it could pull the bow through a cresting wave.
Counteracting Shock-Load	In large seas, constant “finesse” techniques may reduce shock-loading. Counteracting shock load requires the coxswain to constantly observe the towed vessel, and increasing or decreasing towing vessel speed to compensate for the effects of approaching or receding seas on the towed vessel. This takes much practice and experience.
NOTE 	Safety demands emphasis on preventing shock-load and reducing its effects. Shock-loading presents a definite possibility of damage to vessel fittings or tow rig failure. One of the more feared possibilities is towline snap-back. Think of this as a greatly magnified version of stretching a rubber band until it breaks. Remember, some nylon cordage can stretch up to an additional 40% of its length before parting.



Section B. Towing Equipment

Introduction When towing a boat or other maritime craft, always use the proper equipment for the task. Using the proper equipment minimizes accidents and possible injuries. Towing equipment includes:

- (01) Towlines,
- (02) Pendants and bridles,
- (03) Deck fittings,
- (04) Hardware for attaching the towline (skiff hooks, shackles, etc.),
- (05) Fenders,
- (06) Drogues,
- (07) Alongside lines.

This section discusses the design, use, and limits of towing equipment.

In this Section This Section contains the following information:

Title	See Page
Towlines and Accessories	3-13
Heaving Line	3-18
Chafing Gear	3-20
Deck Fittings and Other Fittings	3-21
Drogues	3-23

Towlines and Accessories

B.1. Description Towlines are usually 2-in-1 (double-braided) nylon, two to four inches in circumference. Length can be up to 900 feet. Nylon instead of other synthetic fiber cordage should be used for a good combination of strength and stretch (elongation and elasticity). The Auxiliary is not required to use double-braided nylon for towing and will use a variety of types and sizes of towlines.

NOTE

Refer to line manufacturers guidelines for recommended sizes for various circumferences of towline.

CAUTION !

Do not tow beyond the vessel’s design limits by simply increasing towline size. If the towline’s breaking strength exceeds the limits designed into the vessel’s fittings and structure, damage and structural failure may result.

The towing vessel’s construction, power, size, and fittings determine towline size (circumference). The proper towline will allow a vessel to tow up to its design limits. The towline will part before damage occurs to a vessel’s fittings, structure or hull.



Each Coast Guard boat type has an equipment list that specifies towline length and size. Towlines will usually have an eye spliced into the tow end. Towline length and size will vary on other vessels due to design limits and available space. Offshore or in heavy weather, a towing vessel may need 500 feet or more of towline to keep a towed vessel in step and to minimize the effect of shock-loading.

B.1.a. Towline Storage

Towline is stored typically on a tow reel with the bitter end secured to the reel with small stuff. The line will lie evenly on the reel. More importantly, to quickly slip (release) the towline in an emergency, the small stuff can be cut with a knife, and the bitter end runs free. When putting new cordage in service as a towline, an eye should be spliced at both ends. This will allow an “end-for-end” switch before part of the towline is beyond useful service.

Many tow reels have mechanical advantage (hand crank, gear train) or electric motors to ease towline retrieval. These devices are only to retrieve a slack towline. Crewmembers should not try to take any tension with these devices. The tow reel should be inspected frequently for easy rotation and adequate lubrication.

NOTE 

Unless slipping the towline in an emergency, keep at least four turns of towline on the reel. Paying out the entire length can result in loss of both tow and towline.

B.1.b. Towline Condition and Inspection

Safe and efficient towing requires an undamaged, serviceable towline. Whenever any towline damage is found or suspected, crewmembers must remove or repair the damage. If removing damage shortens the towline to less than serviceable length, then the towline should be replaced. Remaining usable sections of a discarded towline can be used for bridles, alongside lines, mooring lines, etc.

NOTE 

Units shall use applicable ALMIS MPC for towline condition or inspection.

Inspect towlines on a regular basis to detect damage from:

- (01) Cuts.
- (02) Chafing.
- (03) Flattening.
- (04) Fusing (caused by overheating or over-stretching).
- (05) Snags.
- (06) Hardening (heavy use will compact and harden a towline and reduce its breaking strength).

If a towline shows any of these characteristics, it must not be used as a towline.



B.2. Towing Pendants and Bridles

It is not always possible, appropriate, or safe to attach a towline from the stern of a towing vessel to a single point on the bow of a distressed vessel. For instance:

- (01) The distressed vessel's deck layout may not have a single direct run through a bull nose.
- (02) There might not be a sampson post or centered bitt.
- (03) The towline might be too large for deck fittings.
- (04) Deck fittings may be improperly mounted, rotted or corroded where they attach to the deck.

In these cases, a pendant or bridle should be rigged. The pendant or bridle forms part of the tow rig, leading from the eye or thimble of a towline to the appropriate location(s) or deck fitting(s) on the towed vessel. Towing pendants and bridles are made of double-braided nylon or Kevlar. The two most common rigs are a pendant and a bridle.

NOTE

Auxiliary facilities will have a variety of pendants and bridles, not necessarily constructed of double-braided nylon or Kevlar.

When possible, pendants and bridles should be used with breaking strength equal to or greater than the towline.



B.2.a. Pendants

A pendant is used to reduce wear and chafing at the towline end (particularly the eye and its splice). A pendant must be long enough so the towline connection is clear of obstructions on the towed vessel (see [Figure 3-3](#)).



Figure 3-3
Pendant



B.2.b. Bridle

A bridle or “Cats Paw” is used when both legs can be rigged to exert an equal pull on the hull of a distressed vessel, and is preferred for heavy weather towing (**Figure 3-4**). A bridle provides the best results where a towed vessel deck fittings (chocks and cleats or bitts) are not right at the towed vessel’s bow (as a bullnose), or where obstructions (bulwark or rigging) on the bow prevents a pendant or towline from making a direct lead back to the towing vessel. Use the following list as a guideline for attaching a bridle for towing:

- (01) Use a long bridle when the best attachment points for the towed vessel are well aft to either side of the deck, but maintain a fair lead forward to reduce chafe.
- (02) Remember that the amount of tension on each bridle leg increases with the size of the angle between the bridle legs.
- (03) Keep the legs of the bridle long enough so the angle of the legs stays less than 30°.
- (04) The legs must be long enough to reduce towed vessel yaw.
- (05) Protect bridles with chafing gear when necessary.
- (06) Use thimbles in the bridle leg eyes where they meet.
- (07) When shackled to the towline, remember to mouse the shackle pin.

A bridle is also used by towing vessels without centerline towing capability or with transom obstructions (outboard motors or rigging). The bridle is attached to fittings in a manner to clear the obstructions. Again, bridle leg lengths must be equal to share the strain of the tow.

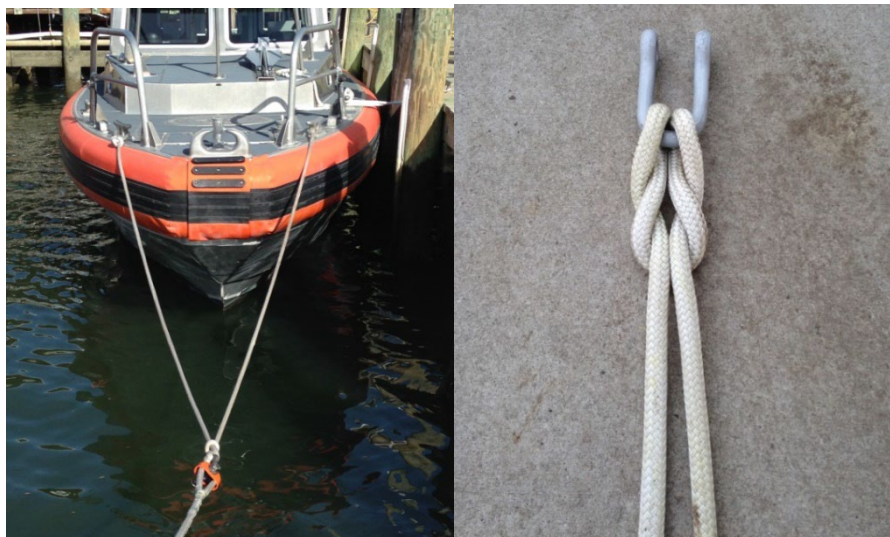

Figure 3-4
Bridle/Cats Paw



B.2.c. Pendant
and Bridle
Condition and
Inspection

Safe and efficient towing requires undamaged, serviceable pendants and bridles. Crewmembers should inspect pendants and bridles on a regular basis to detect damage and to ensure bridle leg lengths are equal. For nylon pendants and bridles, the towline condition and inspection list provided in **B.1.b. Towline Condition and Inspection** should be used.

NOTE 

Inspect towlines, pendants, and bridles after each tow and whenever shock loading has occurred.

Heaving Line

B.3. Description

A towline is too heavy to cast more than a few feet. In rough weather or when impossible to get close enough to throw a towline to a distressed vessel, a heaving line should be used to reach the other vessel. A heaving line is a length of light line used to carry a larger line between vessels.

B.4. Passing a Towline

In most cases, a heaving line or float line will be used to make the initial pass to the vessel in need of a tow. To pass a towline with a heaving line, one end of a small line is attached to the end of the towline and the other end is cast to the other vessel's crew.

The lighter line is used to pull the towline across the distance between the vessels. Sometimes, multiple lines are used as heaving lines.

B.4.a. Heaving Line/Throw Bag

A heaving line is made of light, flexible line with a rubber ball or a monkey's fist at the throwing end. A heaving line must be in good condition, at least 75 feet long, and free of rot or weathering (see **Figure 3-5**).

The bitter end of a heaving line is attached to the towline with a clove hitch, bow line, small carabiner, or snap hook. Slip clove hitches may work best in very cold weather because they are easier to untie. The longest heaves are cast downwind, but this may not always be possible. The throw should be targeted above the center of the vessel so the thrown line crosses over the deck and avoids breaking glass or injuring people.

CAUTION !

Always yell "heads up" before throwing a heaving line or ball. They can cause damage to property or personnel.



Figure 3-5
Heaving Lines



**B.4.b. Float
Line**

To reach a vessel beyond the range of a heaving line or in an inaccessible position, a buoyant synthetic line may be floated from upstream or upwind. One end is tied to a ring buoy or float, the other end to the towline, and the float line is thrown downstream in the direction of the distressed vessel. The current or wind will carry the float line toward the other vessel. This method is only effective if the wind or current can get the float within range of the other vessel.

Chafing Gear

B.5. Description Chafing gear protects towlines, bridles, and pendants from wear caused by rubbing against deck edges, gunwales, bulwarks, chocks, taff rail or tow bars.

B.6. Preventing Chafing Damage Layers of heavy canvas or leather can be tied with small stuff to the towline, bridle, or wire rope at contact points to prevent chafing damage. Sections of old fire hose also work well as chafing gear, or commercially available products may be used. Crewmembers must make sure the chafing gear stays in place for the duration of the tow.

B.7. Thimbles Thimbles are designed to equalize the load on an eye of a line and provide maximum chafing protection to the inner surface of the eye. On double-braided nylon, thimbles made specifically for synthetic lines (see [Figure 3-6](#)) must be used.



**Figure 3-6
Thimbles**



Deck Fittings and Other Fittings

B.8. Description

Fittings are attachments or fair lead points on vessels for tows, anchor lines, and mooring lines. Many fishing and sailing vessels have other attachment points for standing and running rigging that could also provide tow rig attachment points or fair leads. For towing, attachment points and fair leads designed for horizontal loads should only be used.

Common fittings include bitts (mooring and towing), cleats, bollards, and sampson posts. Chocks, tow bars, and taff rails act as fair leads redirecting or supporting the towline. Pad eyes, turning and snatch blocks, winch drums, capstans, and windlasses should also be considered as attachment points or fair leads on a towed vessel. Trailerable boats usually have an eyebolt or eye fitting at the bow for an attachment point.

B.9. Condition and Inspection

The following regular inspections should be conducted of towing vessel fittings:

- (01) Check for cracks, fractures, rust, corrosion, wood rot, fiberglass core softening, or delamination.
 - (02) Inspect surfaces that are normally hidden from view, particularly backing plates and under-deck fasteners.
 - (03) Tow bars are subject to high vibration and may loosen or cause stress fractures around their foundations.
 - (04) Ensure working surfaces are kept free from paint and relieve any surface roughness. A smooth working surface reduces wear, friction and chafing on lines.
-



B.10. Skiff Hook

The typical skiff hook has a quick-release safety buckle and snap hook clip that can be attached directly to the boathook handle (see [Figure 3-7](#)). Skiff hook assemblies are commercially available.

WARNING

Do not over-stress a skiff hook. Never use one for any operation that exceeds the stress load of towing small, trailerable boats.

CAUTION !

Use extreme care when removing a skiff hook from a trailer eye fitting. Even at a dock, crewmembers risk injury from vessel movements.



Figure 3-7
Skiff Hook



B.10.a. Using a Skiff Hook

Perform the following procedures to use a skiff hook:

Step	Procedure
1	Attach the skiff hook line to a towline with a shackle or double becket bend.
2	Use the skiff hook assembly to reach down and place the hook onto a distressed vessel's trailer eyebolt.
3	Pull back on boat hook, releasing snap hook into trailer eyebolt.

Drogues

B.11. Description

A **drogue** is a device that acts in the water similar to how a parachute works in the air. The drogue is deployed from the stern of the towed vessel to help control the towed vessel's motions. Coxswains and boat crews must familiarize themselves with the operating characteristics and effectiveness of available drogues, training with and testing drogues under various conditions to learn drogue capabilities. The time to learn about a drogue is before one is needed to deploy.

B.11.a. Towing Conditions

While trailing a drogue from the towed vessel is not common, it may be useful when a distressed vessel has lost rudder control. Normally drogues are not deployed when well offshore but rather inshore where greater control of the towed vessel is required. If necessary to tow a vessel with large swells directly on the stern, it may be more prudent to alter course or lengthen the towline rather than to deploy a drogue. Drogues are typically used when the tow is shortened as in preparing to tow into a bar or inlet. With a short hawser and large swells on the stern, the drogue is deployed to prevent the towed vessel from running up the stern of the towing vessel or "surfing" down the face of a wave. The drogue keeps a steady strain on the towline reducing shock-loading.



B.11.b. Drogue
Size

The idea of the drogue is to provide backward pull on the stern of the towed vessel so that the wave will pass under the boat. It is important to match the size of the drogue to the towed boat, its deck fittings, and its overall condition. Larger, well-constructed cone drogues can exert a very large force on a boat's transom so the towed vessel's stern must be carefully examined.

Different-sized drogues are used for different conditions and different vessel sizes. A modern style drogue (**Figure 3-8**) is a synthetic material cone, with the pointed end open. Drogues may have a ring in the base of the cone (the leading edge) to which attaches a four-part bridle. The other ends of the bridle connect to a swivel, which in turn, connects to a line made fast to the stern of the towed vessel. The towed vessel "tows" the drogue. Drogues sometimes have another line (dumping line) attached to the tail end for retrieval.

NOTE 

A large drogue can cause stress that will damage a boat. For a boat, the larger the drogue used, the slower the towing speed must be. A slight increase in speed causes a tremendous increase in drogue tension.



Figure 3-8
Modern Drogue Types



B.12. Inspection and Preparing the Drogue Gear

To inspect and prepare the drogue gear, perform the following procedures:

Step	Procedure
1	Visually inspect the drogue rig for tears, cuts, holes, worn rusted or corroded fittings and swivels, correct size shackles, and untangled bridles.
2	Inspect the drogue towline and bridle using the same guidelines for towlines and bridles as listed in B.1.b. Towline Condition and Inspection.
3	Ensure that the drogue has 200 feet of two-inch, double-braided nylon line properly attached to the bridle swivel using a correctly sized shackle. Make sure it has no sharp fittings or exposed wires and is stowed in a manner that will keep it intact until it is deployed.
4	Place all equipment in a synthetic gear bag with laminated written instructions and illustrations on how to rig a drogue, both with and without a bridle.
5	Provide all necessary equipment with a drogue rig such as extra shackles, bridles, dumping line, straps, and chafing gear to achieve the best possible connection on the stern of a tow. At night attach a chemical light to the bag and include a flashlight inside.

NOTE 

Auxiliary facilities are not required to carry drogues.

NOTE 

Determine the fittings to which the drogue will connect, how to make the connection, and how much line to deploy before sending it to the tow. Always ask about backing plates, fitting sizes, and strength of materials involved. Be cautious if an attachment point cannot be seen. Rely on experience and judgment.



B.13. Directly Passing the Drogue

Perform the following procedures to pass the drogue:

Step	Procedure
1	Attach flotation to the bag (usually a fender) and two lines, each at least 25 feet in length, to the handles of the gear bag. Bend a heaving line or buoyant rescue line onto one of the lines.
2	Pass the drogue directly from the towing vessel to the towed vessel when in the best position.
3	The drogue and line can be heavy and awkward for the crew of the distressed vessel. If possible, maneuver the rescue vessel to pass the drogue to an area on the distressed vessel where the crew will not have to lift the apparatus a long distance.
4	Instead of immediately taking a boat in tow, stand by and watch the distressed vessel crew ready the drogue rig for deployment.
5	Provide visual inspection, verbal direction, and clarification if necessary.

NOTE

Unless a crewmember from the towing vessel goes aboard the towed vessel, the towed vessel crew must carry out the following procedures. Provide them guidance and direction as needed.

B.14. Rigging the Drogue for Deployment

Perform the following procedures to rig the drogue for deployment:

Step	Procedure
1	Use attachment fittings as near the centerline as possible.
2	On many vessels, a bridle will be needed to spread the load between two separate fittings to center the drogue.
3	Winches, motor mounts, masts, and davit bases are other possible locations for good strong connections.
4	When trying to compensate for a jammed rudder, attach the drogue well off the centerline, close to the quarter, opposite the side where the rudder is jammed.
5	Connect the bridle legs or the drogue lines to the appropriate fittings.



B.15. Deploying the Drogue

Perform the following procedures to deploy drogue when vessel is being towed astern:

Step	Procedure
1	Move the tow forward slowly, just enough to control the tow, while the towed vessel's crew prepares to deploy the drogue.
2	Direct the towed vessel's crew to connect the bitter end of drogue line to a cleat or other reinforced attachment point.
3	Direct the towed vessel's crew to put the drogue in the water, and pay out the line slowly from a safe position.
4	Pay out all 200 feet of drogue line, unless circumstances direct.
5	Once the drogue sets and starts to pull, slowly increase speed while the distressed vessel's crew observes the rig.
6	Check attachment points and effectiveness of the drogue. If adjustments must be made, slow down and make them.
7	Once the drogue is deployed, pick the most comfortable course and speed. Control of the tow is more important than speed. Towing a drogue at too great a speed may damage the towed vessel or may cause the drogue rig to fail. One of the crew on the towed vessel should monitor the drogue.

WARNING

Drogue use does not justify towing through breakers. When in doubt, stay out.



B.16. Shortening Up and Recovering Drogue

Because a tripping line is not recommended, several alternate recovery methods are available. If recovery is not properly set up and controlled, a drogue may become fouled on the tow, a buoy, or other object. Perform the following procedures to shorten up and recover the drogue:

Step	Procedure
1	Slow or stop the tow, then haul it in. The primary method for shortening up or recovering a drogue is accomplished by slowing the tow or stopping completely. Have people onboard the towed vessel slowly pull in the deployed drogue. Provide enough maneuvering room to bring the tow around on a course causing little or no tension on the drogue line during recovery.
2	Haul the drogue to the stern and recover and pull the dumping line (if attached). When pulled, it inverts the drogue making it easy to recover. A dumping line is only suitable for large drogues that drain slowly.

B.17. Storing Drogue

Perform the following procedures to store the drogue:

Step	Procedure
1	Conduct freshwater rinse of drogue and all hardware.
2	Allow the drogue and hardware to completely dry prior to stowage.
3	Use a synthetic gear bag to hold the drogue for storage and deployment.
4	Store drogue equipment in accordance with platform specific operator’s handbook.

Other Equipment

B.18. Description

Alongside lines, fenders, and general hardware account for other equipment that may be necessary to employ for towing evolutions.

B.19. Alongside Lines

At some point during a tow, the towing vessel most likely will need to tow the distressed vessel alongside or moor to the towed vessel. The towing vessel will usually need a combination of lines to allow for vessels of different size.

B.19.a. Alongside Line Storage

The boat equipment list specifies number, length and size of alongside lines for vessel type. Stowage and weight considerations will guide other vessel types.



B.19.b.
Alongside Line
Condition and
Inspection

Alongside lines must be kept in the same condition as towlines and bridles (see **B.1.b. Towline Condition and Inspection**).

B.20. Fenders

Fenders are portable rubber, synthetic, or foam devices that protect a hull when maneuvering in close proximity to other vessels, docks or pilings. Fenders have either eye(s) or a longitudinal hole for attaching lines. They can be spherical, cylindrical, or rectangular prisms. Fender size varies greatly, and the appropriate size should be used depending on the situation. Fenders that will keep space between vessel hulls or rub rails and hulls should be used.

B.21.a. Fender
Deployment

Fenders should be used whenever there is the possibility of a hull making contact with another object. They should be strategically placed to account for different hull shapes (maximum beam, tumble-home, flare) or appendages (rub rails, spray rails, trawl rigs, platforms).

WARNING 

Never use hands or feet to fend off another object (pier, boat, buoy). This could result in serious physical injury. Always use a fender!

B.21.b. Fender
Placement

Because vessels are shifted around by water, fenders may need to be moved for best effectiveness, even after strategic placement. Most vessel crews are too small to have a dedicated fender tender; therefore, the need should be minimized beforehand.

B.21. General
Hardware

General hardware for use in towing includes shackles, snap hooks, carabiners, swivels, and other items, that should have the following characteristics:

- (01) These items must be made of strong, low-maintenance materials.
- (02) They must be easy to connect and disconnect or open and close by all crewmembers.
- (03) All hardware should resist distortion.
- (04) Shackles need a large enough opening to easily cross an eye or thimble. Captive-pin (safety) shackles should be used wherever possible. The pin should be attached to the shackle with a lanyard to prevent pin loss.

When using general hardware, crewmembers should be sure to:

- (01) Keep all hardware clean and lubricated. Inspect hardware after each use.
- (02) Be particularly cautious of hardware that has been shock-loaded.
- (03) Immediately replace any hardware that is distorted, spreading, excessively worn, or stripped.



Section C. Standard Towing Procedures

Introduction The procedures listed below are derived from time-tested, experience-based techniques proven to be effective, safe, and efficient. They shall be real actions performed by coxswain and crew. Some of the actions can be executed at the same time to minimize duplication or avoid wasting time. In extreme conditions or emergencies, some actions may not be possible. If actions must be skipped, potential risks should be assessed and managed. If a problem occurs at any step in the procedures, it may be safer and easier to “backup” to the last successfully completed step and restart.

In this Section This section contains the following information:

Title	See Page
Pre-Towing Procedures	3-30
Towing Astern	3-36
Connecting Tow Rig to Fittings	3-49
Connecting Tow Rig to a Trailer Eye	3-51
Transitioning to Stern Tow	3-52
Underway With Stern Tow	3-54
Compensating for Current	3-59
Shortening the Tow	3-65
Towing Alongside	3-70
Sinking Tows	3-75

Pre-Towing Procedures

C.1. Description The amount of effort put into preparing ahead of time will pay off with safer, easier execution of the tow.

NOTE 

Throughout the entire towing evolution, open communication between the coxswain, boat crew and towed vessel is absolutely necessary for safety and repeat backs should be used.



C.2. Receiving Notification and Accepting Task

When notified of a towing mission, the coxswain takes the following procedures as common practice:

Step	Procedure
1	Get as much critical information as necessary.
2	Write down the information.
3	Develop a full understanding of the situation.
4	Make a conscious decision to “accept” the tasking.

The coxswain is ultimately responsible for mission execution, so the tasking should only be confirmed in view of vessel and crew capability. If tasking exceeds vessel or crew capability, particularly if not an actual distress case, the coxswain’s concerns should be made clear. Vessel towing limits, maximum range, sea-keeping, crew fatigue, etc. are all essential considerations to assess and manage potential risk.

NOTE

Keep a brief (plastic clipboard and grease pencil) written record of critical information. Include vessel information (length, type, displacement, disability), number of persons on the boat, position, and environmental conditions. A written record allows the crew to concentrate on task completion without having to later rely on memory for needed facts. Repeating information over the radio is frustrating and distracting. As information changes, update your records and notify your unit.

C.3. Briefing the Crew

The coxswain shall brief the crew as follows:

Step	Procedure
1	Conduct a thorough boat crew briefing.
2	Explain the situation and what might be expected, using the facts.
3	If there is any confusion or uncertainty, clear it right away.
4	The crew must participate and ask relevant questions.
5	Assign personnel to assist with preparations and collect any needed tow rig or assistance items not aboard the towing vessel.
6	Ensure proper safety and personnel protective equipment is donned by the crew.



C.4. Evaluating Conditions

Boat crews shall evaluate conditions for a tow as follows:

Step	Procedure
1	Note how the different environmental conditions will affect the operation.
2	As conditions may likely change during the mission, estimate which phase of the mission will encounter which conditions and whether on-scene conditions will be different from those en route.
3	Report the present and forecast and update as necessary. Necessary condition information includes: <ul style="list-style-type: none">(01) Existing and forecast marine weather (including winds, seas, bar conditions).(02) Currents and tide (next high/low, slack/maximum).(03) Daylight/Darkness (sunrise/sunset, twilight).

C.5. Operating and Navigating the Vessel Safely

The only way to perform the tow is get there safely. A sense of urgency should never affect judgment. For safe operation and navigation, the following precautions apply:

Step	Procedure
1	Maintain safe speed for the conditions (seas, visibility, and other traffic).
2	Keep constant awareness of navigational position and navigational hazards.
3	Stay aware of the distressed vessel's position.



C.6. Communicating with Distressed Vessel

Contact should be made with the distressed vessel, if possible. Communication shall be as follows:

Step	Procedure
1	Provide the distressed vessel with ETA.
2	Advise persons on the distressed vessel to put on PFDs (if this has not been done already).
3	Get details of deck layout, fittings and backing plates. Ask about the size of chocks and cleats to determine size of towline, bridle or drogue.
4	Ask for information the distressed vessel's crew thinks is important before arriving on scene (lines or gear in the water, nearby vessels, etc.).
5	Determine if anything has changed since the distressed vessel's last contact with the Operational Commander.
6	Ascertain any sense of heightened urgency.
7	Inform the distressed vessel that once on scene, conditions will be observed and final preparations made before setting up the tow and further instructions will then be provided.
8	Establish and maintain a communications schedule.

C.7. Preparing Equipment

Equipment shall be prepared for the tow as follows:

Step	Procedure
1	With the information known, begin to plan a tow rig.
2	Ready all necessary equipment and re-inspect it (i.e., towline, bridle, shackles, knife, heaving lines, heaving line, chafing gear, etc.) as directed by the coxswain.



C.8. Performing an On-Scene Assessment

Once on-scene, use the following procedures:

Step	Procedure
1	Watch the vessel's movement (pitch, roll) in the seas and determine the effect of wind and current on the distressed vessel's drift rate and lateral movement. Compare it to own vessel's drift. Knowing the different drift rates will help determine the best approach.
2	Evaluate the location and any abnormal condition of deck fittings.
3	Confirm the number of persons onboard and ensure they are wearing PFDs.
4	Note any unusual conditions that may affect towing procedures (i.e., loose gear, rigging, or debris in the water).
5	Communicate any concerns to the distressed vessel.
6	Decide whether to put a crewmember aboard the distressed vessel.
7	Decide if it is best to remove the crew from the distressed vessel.
8	Determine if an equipment transfer (drogue, pump, radio) will be necessary.
9	After evaluating the on-scene situation and making risk assessment, decide whether to tow or not.

NOTE

During the period of pre-tow, on-scene analysis is when crew experience and judgment on both vessels must mesh. Discuss concerns before directing action. The distressed vessel's crew may have information that the towing vessel's crew does not. The easiest way to get the big picture may be by circling the distressed vessel, if possible. A method to check drift rate of the distressed vessel is to maneuver the towing vessel onto the same heading as the distressed vessel and stop astern of it. If the distance between the vessels increases, one vessel has a higher drift rate. Note the different angles or aspects the towing vessel and the towed vessel hold towards the winds and seas. The only time the drift rate and aspect will be exactly the same is if the vessels are exactly the same.



C.9. Making-Up the Tow Rig and Preparing for Transfer

Crewmembers should visualize the tow in progress, given all the factors identified in the on-scene assessment. This may help identify any special considerations. Elements of the tow rig should be appropriately sized for the specific distressed vessel (i.e., a 3-inch towline with eye might not fit through a bow chock or around a cleat of a 25-foot boat).

Step	Procedure
1	Set up the tow vessel deck with all equipment staged and ready.
2	Attach 2 heaving lines (one primary, one backup) to the tow rig.
3	Assign crewmembers to each heaving line, and to bitt or line handler duties.

NOTE

Pass equipment (pump, drogue, etc.) and transfer personnel before making the approach to transfer the tow rig.

C.10. Determining the Approach

Though optimal to make an approach from downwind and down sea, the drift and aspect of the distressed vessel may determine the approach. Vessels with a large superstructure forward or outboard-powered engine will tend to lay stern-to the wind. A vessel with deep draft and low superstructure will generally lie broadside to the seas. Of course, there are many positions in between. The approach to a vessel drifting down wind and down sea, “stern to” the wind and seas will be different from the approach to a vessel lying “beam to.” The usual approach by a boat to make a tow is with the bow into the seas.

Once the coxswain has determined how to make the approach he/she shall inform the crew, specifically telling them:

- (01) From which side to pass the tow rig (or equipment).
- (02) When (in what relative position of the two vessels) to pass the tow rig.
- (03) Whether to use a heaving line.



C.11. Briefing the Distressed Vessel

Perform the following procedures when briefing the distressed vessel:

Step	Procedure
1	If transferring crew or equipment before the tow, relate when and how.
2	Explain plans and pass safety instructions. Include enough information so the distressed vessel's crew does not have to ask questions once the approach begins.
3	Describe the towing approach.
4	Tell when and how the tow rig will be passed.
5	Give tow rig connection instructions (how to lead, where to attach).
6	Inquire about type and condition of tow connection points.
7	List emergency breakaway procedures.
8	Describe emergency signals.
9	Instruct on general safety during the approach and passing the tow rig.

NOTE

Limit the content of this briefing to information the distressed vessel needs to know before the tow begins. Once hooked up and in tow, there will be opportunity to pass additional information.

Towing Astern

C.12. Description

The most common towing technique is to tow the distressed vessel from astern of the rescue vessel.



**C.13.
Establishing a
Danger Zone**

Before starting the approach, an imaginary danger zone is established around the distressed vessel and the approach is made from the outside. The size of a danger zone depends upon conditions and the arrangement of the distressed vessel. The poorer the conditions, the larger the danger zone (**Figure 3-9**).

NOTE 

A boat crew's teamwork, communications, and experience are key to a safe, successful approach.

Wind/Seas

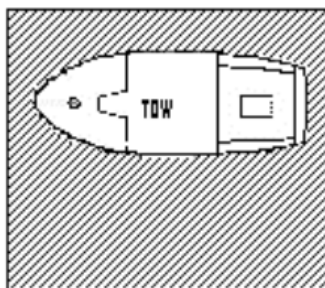

**Figure 3-9
Danger Zones**

**C.14. Making
the Approach**

The on-scene assessment gives the knowledge of how conditions affect both vessels. Knowledge and experience with the towing vessel's handling and maneuvering should allow to overcoming conditions and putting the towing vessel in a safe position for the crew to pass the tow rig.

**C.15. Safe
Distance**

Safe distance keeps you out of the danger zone. It gives your crew time to pass the towing rig. It minimizes stress levels and increases situational awareness. Safe distance is different for each operator. You may have to close to get a heaving line across in heavy weather, but regain that safe distance before attempting to pass a towline.



C.16. Optimum Position

Optimum position is the position taken by the rescue vessel which allows the crew the safest opportunity to pass the towing equipment to the vessel to be towed. Optimum position provides better vessel control, while keeping appropriate distance from the distressed vessel and maintaining a safe escape route in case of an emergency.

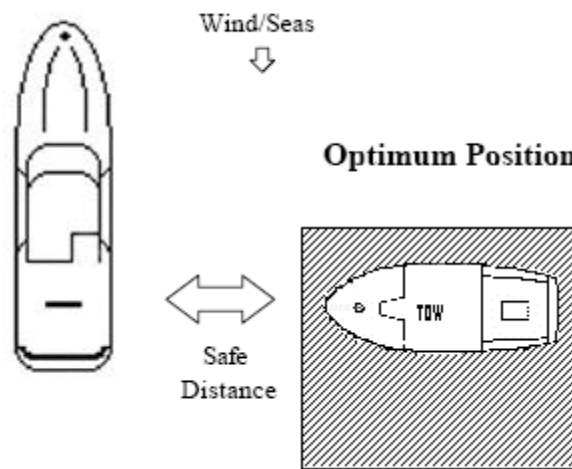
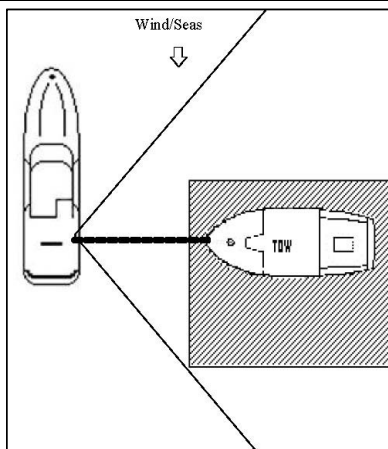

**Figure 3-10
Optimum Position**



**C.17.
Maneuvering
Zone**

Maneuvering Zone is a 90-degree arc; 45-degrees forward and 45-degrees aft of your tow bitt. It is a guide to keep you in optimum position and allow you to safely maneuver the boat. Staying in the maneuvering zone keeps you out of the danger zone and gives you a way out if you encounter problems while station keeping. Use the heaving line, your towing bitt, and the disabled boats attachment point as a reference. Coxswains need to keep their attention divided between the disabled boat and the seas. Coxswains will rely heavily on their crew to assist them with all aspects of the evolution.



**Figure 3-11
Maneuvering Zone**



**C.18.
Maneuvering to
an Optimum
Position**

Optimum position is when the towing vessel provides the safest opportunity to pass the towing equipment to the vessel to be towed. Optimum position provides better vessel control, while keeping appropriate distance from the distressed vessel and maintaining a safe escape route in case of an emergency. Perform the following procedures to maneuver to this optimum position (**Figure 3-10**):

Step	Procedure
1	In calm conditions, make the approach at an angle that allows the crew the best opportunity to pass the tow rig.
2	In heavy weather or surf conditions, make the approach into the prevailing wind and seas. If the wind is different from the seas, make the approach into the seas. This usually maximizes control for the coxswain and ensures the most stable platform for the crew. A coxswain may split the difference between the wind and seas to hold station.
3	Make the approach at the slowest speed necessary to maintain steerage.
4	Once in the optimum position, station keep on the distressed vessel. Station keeping maintains the position and heading relative to the weather and seas outside the danger zone. This is usually done by use of helm and engine control.
5	To station keep, the coxswain must simultaneously focus on the seas, the bitt and line handlers, and the position with respect to the distressed vessel.
6	Maneuver and apply power early and smoothly as distance and angle to the distressed vessel change.
7	If the towing vessel begins to move towards the danger zone, maneuver to open the distance.
8	If the distressed vessel begins to get away from the towing vessel, close the gap.
9	Use correcting maneuvers (opening and closing) before a problem develops. A small correction early can prevent a large problem later.
CAUTION !	The coxswain must let crewmembers know before making correcting maneuvers so that they can tend lines and ready themselves.
CAUTION !	Maneuver as required, but it is preferable not to make opening and closing maneuvers when lines are over (except the heaving line). Avoid making correcting maneuvers on the face of a wave.



NOTE 

Actual maneuvering techniques vary from vessel to vessel and are mastered by practice and experience. Actual station keeping techniques also vary as the specific wind and sea conditions affect the specific distressed vessel.

C.19. Station Keeping While in Optimum Position

The following procedures apply for station keeping:

Step	Procedure
1	The coxswain now must station keep outside the danger zone and in a maneuvering zone (usually a 90° arc, from 45° off the bow to 45° off the stern, with the distance between vessels no greater than the length of the heaving line) for the crew to pass the tow rig.
2	The coxswain must continue station keeping until the tow rig is connected and the transition to towing astern begins.
3	The crew must make every effort to ensure that passing the tow rig goes smoothly, quickly and safely.
4	In calm conditions, station keeping may simply be holding the nearest safe position to take advantage of the best angle for the crew to pass the tow rig. However, even though conditions may be calm, a vessel's wake or a current can suddenly increase the chance of hull-to-hull contact with the distressed vessel. A safe escape route shall be planned for all approaches and while station keeping.



**C.20. Passing the
Tow Rig**

Once optimum position (**Figure 3-12**) is maintained, the tow rig may be passed as follows:

Step	Procedure
1	All lines, equipment, and connections should already be inspected, made ready, and double-checked.
2	Minimize loose towline on deck by paying out directly from the reel.
3	If the towing vessel is not equipped with a towline reel, fake the towline carefully so that it will not kink or tangle.
4	In heavy weather, use caution to ensure line is not washed over the side and into the screw or water jet intakes.

NOTE 

While passing and connecting the tow rig, and transitioning to stern tow, use loud and clear communication between crewmembers and coxswain to prevent accidents. Whenever the coxswain directs an action, a crewmember must take that action and reply that the action has been taken. Whenever a crewmember advises the coxswain of status or action, the coxswain must acknowledge same.

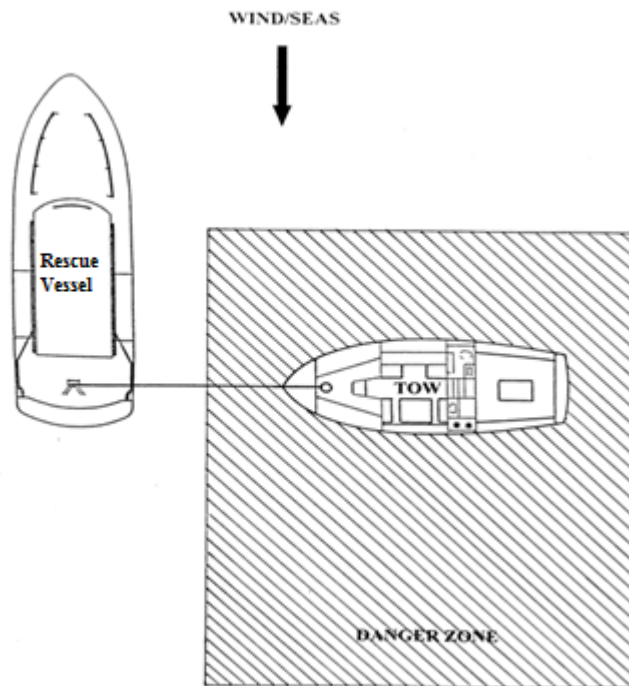

Figure 3-12
Optimum Position for Passing the Tow Rig



C.20.a. Calm Conditions

When passing the rig in calm conditions (no heaving line), the following procedures apply:

Step	Procedure
1	Coxswain directs crew to pass the rig.
2	Line handler hands over or carefully tosses the end of the rig to a person on the distressed vessel. The person receiving the rig must be physically able to haul it to the connecting point and then attach it properly.
3	Line handler advises coxswain that the rig is away.
4	Line handler tends towline as required to eliminate any risk of fouling the propellers, waterjets, rudders, rigging, or other fixtures.
5	Line handler advises the coxswain when the action has been successfully executed, and when the towline is properly secured to the towed vessel.

C.20.b. Using a Heaving Line

When passing a rig using a heaving line the following procedures apply:

Step	Procedure
1	Wet both heaving lines to make them more flexible and minimize risk of them becoming tangled.
2	Take two-thirds of a heaving line coil into the casting hand leaving the remainder in the other hand.
3	Check that the area is clear of people and obstructions.
4	Advise coxswain when ready, “I have a shot” and await direction before casting.
5	Coxswain direct cast.
6	Call out “HEADS UP” as a warning to people onboard the distressed vessel to take cover and watch out for the toss.

NOTE 

It takes practice to cast a heaving line properly. Adapt technique to conditions for a safe and successful result.



C.20.c. Casting
a Heaving Line

When casting a heaving line, the following procedures apply:

Step	Procedure
1	Cast a heaving line so it falls across the distressed vessel's deck.
2	Tell coxswain when the heaving line has been cast and whether it has been retrieved; fell short, or missed altogether.
3	Advise the coxswain whenever a line is in the water, so no maneuvering will be done which could possibly foul the propellers.
4	If the first cast is not retrieved, quickly recover the line and advise coxswain when the second heaving line is ready. When coxswain directs, repeat the procedures.
5	Once line is successfully received on the disabled vessel, untie the unused/unretrieved heaving line from the tow rig (take care to untie the correct line) and advise the coxswain that the rig is ready to be transferred.
6	Coxswain will direct to send the rig; crew replies and begins transferring the rig. Tend the heaving line (if used) to reduce the risk of it becoming fouled. Once the rig starts across, maneuvering opportunities become very limited.
7	Advise the coxswain of tow rig transfer progress (when bridle is clear or aboard distressed vessel, when towline is going over or aboard, etc.).



C.21. Opening and Closing Maneuvers while Towing

Opening and closing maneuvers are used to maintain optimum position and a safe distance while staying inside the maneuvering zone. These procedures are performed prior to passing the towline. A coxswain must use power consistent with the environmental conditions and timely and deliberate throttle inputs to achieve the desired results. Opening maneuvers consist of opening by pivoting or opening by backing. Closing maneuvers consist of closing by pivoting or closing by quartering. The following procedures are often used for opening and closing maneuvers:

The towing transition occurs once the towline is secured to the disabled vessel and the rescue craft maneuvers to pay out the towline to the desired length to take the vessel into stern tow. In heavy weather it can be one of the most hazardous periods. The coxswain must leave the safety of the maneuvering zone to put the tow behind while the crew is paying out towline.

Some basic rules of transition are:

- (01) Communicate with the crew.
- (02) Begin the transition in optimum position (**Figure 3-10**).
- (03) Take the time necessary.
- (04) Get distance between the boat and the disabled vessel.
- (05) Try not to tow the disabled vessel until paying out the desired amount of towline.
- (06) Pay out the towline while in the trough or quartering the swell to reduce surging of the towline.

C.22. Opening by Pivoting

	<p>Open-by-Pivoting Procedures</p> <ol style="list-style-type: none"> 1. Notify your crew! 2. Pivot your boat so your bow moves the disabled boat. 3. When you reach an angle of 45 degrees begin backing away. 4. Once your bow becomes even with disabled vessels bow, pivot away disabled vessel. 5. Put your bow into the conditions and drive back into optimum 6. Stop the boat in optimum position.
--	-------------------------------------------------------------------------------------------------------------------------------------------------------------------------------------------------------------------------------------------------------------------------------------------------------------------------------------------------------------------------------------------------------------------------------------------------------------------------------



C.23. Opening by Backing

	Open-by-Backing Procedures	
	<ol style="list-style-type: none"> 1. 2. 3. 4. 5. 6. 	<p>Notify your crew!</p> <p>Back square to the conditions, throttles.</p> <p>When your bow is clear of the vessel, pivot away from the disabled vessel.</p> <p>Move ahead.</p> <p>When you approach optimum pivot back into the conditions.</p> <p>Stop the boat in optimum position.</p>

C.24. Closing by Backing

	Closing-by-Backing Procedures	
	<ol style="list-style-type: none"> 1. 2. 3. 4. 5. 6. 	<p>Notify your crew!</p> <p>Back square to the conditions, throttles.</p> <p>Pivot your boat so your bow moves the disabled boat</p> <p>Move ahead.</p> <p>As you approach, pivot away from disabled vessel.</p> <p>Stop the boat in optimum position.</p>



C.25. Closing by Quartering

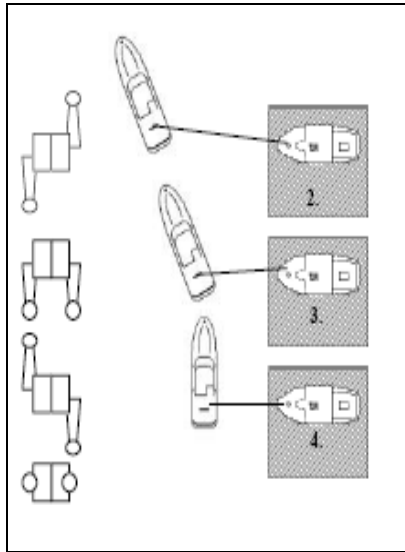

Closing-by-Quartering Procedures

1. Notify your crew!
2. Pivot away from the disabled
3. With the heaving line tending off quarter back.
4. When enough line has been and square up.
5. If you still need to close, close by
6. Stop the boat in optimum position.



C.26.
**Connecting the
Tow Rig**

Methods of tow rig connection (**Figure 3-13**) generally available are:

- (01) Tow rig to fittings.
- (02) Tow rig to trailer eye.

CAUTION !

Though deck fittings should be checked during pre-tow procedures, do not hesitate to stop the connection if something is wrong. If necessary, recover the rig and transfer a crewmember to the distressed vessel to physically inspect the fittings.

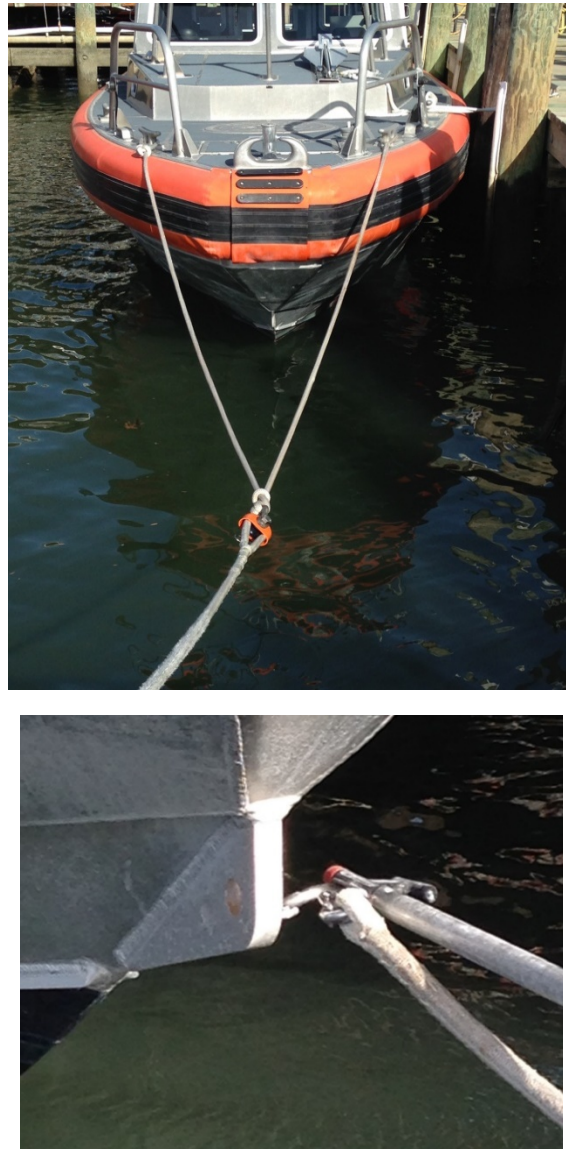

Figure 3-13
Bridle and Trailer Eyebolt Tow Rig Connection



Connecting Tow Rig to Fittings

C.27. Description

The attachment point(s) for a tow rig must be sound. Towing places a tremendous strain on deck fittings, especially in rough conditions. On the distressed vessel, bow bitts, forward cleats and Samson posts will usually provide the best attachment points. Fittings secured to a deck with through bolts and backing plates or those secured to the keel or structural framing should always be used. Other fittings, such as pad-eyes or capstans, may also provide solid attachment points.

Unless the towing vessel puts a crewmember aboard the distressed vessel, the towed vessel crew is responsible for these actions. A good brief to the distressed vessel will address each item, but in the rush to get things set up aboard the distressed vessel, the crew may forget important steps. The towing vessel crew must closely watch, and advise when necessary.

CAUTION !

Transfer of people between vessels is not a common practice. Whenever this is considered, it must be conducted with extreme caution for the safety of people on both vessels.

CAUTION !

Avoid connecting the towline to an off-centerline fitting on the towed vessel. Use a bridle for an equal amount of strain on both sides of the bow.

C.28. Ensuring a Fair Lead

When ensuring a fair lead, the following procedures apply:

Step	Procedure
1	Lead a single point tow rig (pendant or towline) through or to a fitting as close to the centerline as possible. Once led through a secure chock near centerline, the end of the rig can go to a suitable deck fitting.
2	Lead the parts of a bridle through chocks equally spaced from the centerline.



C.29. Making Fast to Fittings

When making fast to fittings, the following procedures apply:

Step	Procedure
1	Connect the eye of a pendant or towline to posts, bitts, or cleats so that it will not come loose when a strain is placed on the rig.
2	Connect the bridle to fittings located at points that allow equal pull to be exerted on them.
3	Check that the center of the bridle is on centerline or the extension of the centerline.
4	Minimize the angle made where the bridle joins the towline by using fittings as far forward as possible (Figure 3-14).

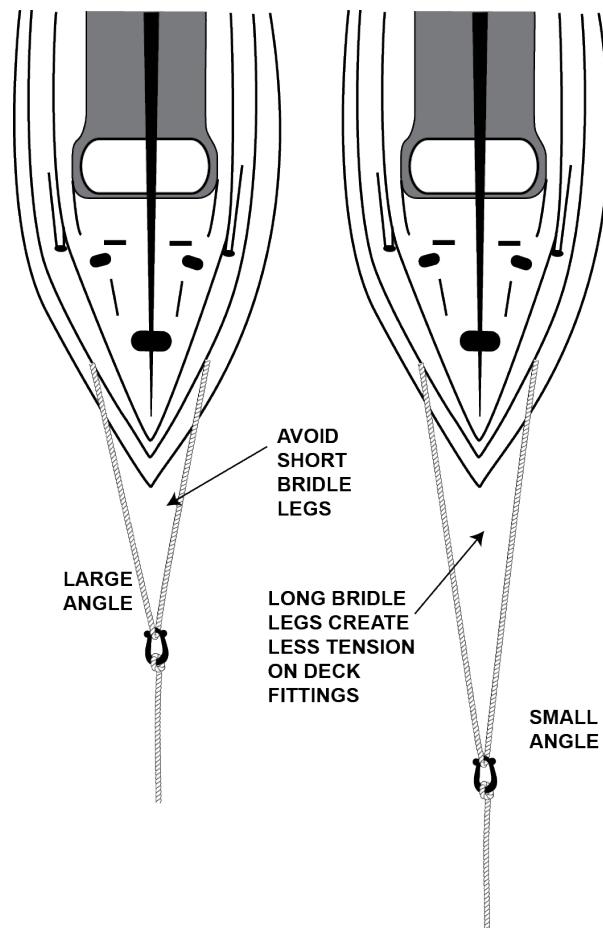

Figure 3-14
Towline Connection Showing Bridle Angle



C.30. Installing Chafing Gear

Where necessary, when installing chafing gear the tow rig should be protected from abrasion or chafing, particularly if the rig takes a sharp turn at chocks or comes close to contact with any obstructions.

Connecting Tow Rig to a Trailer Eye

C.31. Description

On smaller, trailerable boats, the trailer eye is frequently the sturdiest fitting available to attach a tow rig. Attaching a towline to the trailer eye is a dangerous technique. It requires the towing vessel to maneuver very close to a distressed boat and requires crewmembers to extend themselves over the side between two vessels, or under the flared bow sections of the distressed boat.

CAUTION !

To reduce risk in connecting the tow rig to the trailer eye, use a skiff hook.

C.32. Attaching the Skiff Hook

A skiff hook with a quick-release safety buckle and snap hook clip is in common use. Manufacturer instructions should be reviewed for its proper use. The skiff hook requires the following procedures:

Step	Procedure
1	Connect the skiff hook pendant to the towline using a double becket bend or shackle.
2	Slide the skiff hook into snap hook clip located on the boat hook handle.
3	While keeping the pendant taut, extend the boat hook and connect the skiff hook into the trailer eye while pulling the boat hook away.

WARNING

Do not use a shackle to directly connect a towline to a trailer eye. This requires crewmembers to get too close under the bow of the distressed vessel.



Transitioning to Stern Tow

C.33. Moving Away

When moving away, the following procedures apply:

Step	Procedure
1	Once the towline is secured on the distressed vessel, a member of the boat crew should ensure persons on the towed vessel are cleared of the bow.
2	Slowly move the towing vessel out of optimum position and the maneuvering zone.
3	Give particular attention to the direction the towline tends and the amount of slack in the line, ensuring line is tended during maneuvering.
4	The coxswain instructs the crewmember to take a Working Turn on the bitt.
CAUTION ! Do not put a working turn on the bitt until the rig is securely fastened to a tow and POBs are clear of the bow.	
5	Pay out towline gradually in conjunction with the towing vessel's movement.
6	Slowly maneuver to a position in line with the towed vessel's centerline (if maneuvering room permits).
7	Always start the tow by pulling the disabled vessel ahead. Do not try to turn the vessel right away. Pulling on a vessel at a sharp angle increases the initial strain on the towline, could damage equipment, or possibly capsize the boat.



**C.34.
Maneuvering to
Pay-Out Course**

Once the distance allows clear movement of a tow the towing vessel can be maneuvered to allow a smooth pay-out of the towline. As tension increases in the towline, static forces will be felt as the tow rig tries to move the towed vessel. Transitioning is the initial test of strength and performance for the tow rig and connections. Each towing vessel will react uniquely to this initial resistance. The pivot-point distance, propulsion and steering, and size difference between towing and towed vessels and weather will determine how the towed vessel will react. Actual maneuvering techniques are mastered through practice and experience. Minimize surge and shock-loading.

CAUTION !

Gradually come to a pay out course. Rapid movements or changes in direction increase the risk of:

- (01) Fouling the towline in propellers or on deck fittings.
- (02) Shock-loads.
- (03) Loss of towline control.

The boat crewmember must have complete control of the towline. Too much towing vessel headway may cause the crewmember to lose control of towline tension, and the towline will start to run out.

WARNING 

Crews risk injury from a running towline, with the possibilities of injuring their hands and arms in the tow bitt, tow reel, or in bights of line faked on deck. If the towline starts to run, reduce speed immediately. The crewmember working the tow bitt should regain control of the towline after the line stops running.

**C.35. Paying-
Out the Tow
Line**

Paying out towline should be continued until the initial amount of towline scope is satisfactory.

**C.36. Making Up
the Bitt**

Once the desired scope of towline is deployed, the coxswain directs the crew to make up the bitt. Forward motion should be slowed enough to slack the towline, and then the proper turns can be applied.

WARNING 

Do not attempt to make up the bitt with a strain on a towline. This increases risk of injury by catching hands, fingers, and arms between the bitt and the towline.

**C.37. Setting a
Towing Watch**

The towing watch has a critical responsibility. In addition to the crewmember assigned, it is a collateral duty for all other crewmembers. The condition of the vessel in tow and the towline must be constantly monitored.

Refer to **Towing Watch** on page 2-24 for further information on tow watch responsibilities.



Underway With Stern Tow

C.38. Description The best course to safe haven is not always the shortest distance. A course that gives the best ride for both vessels should be chosen. At times, the vessels may have to tack (run a zigzag type course) to maintain the best ride. A firm understanding of the dynamic forces in towing help to ensure a safe tow.

C.39. Briefing the Towed Vessel The following instructions and information that will apply to each step of the tow astern should be shared with the towed vessel:

- (01) General safety (PFDs, staying clear of tow rig, tow rig chafe, location of crew).
 - (02) Equipment (pumps, drogues).
 - (03) Steering (whether to man helm or lock rudder amidships, whether to steer on towing vessel stern).
 - (04) Route to take, expected weather and seas, destination, ETA.
 - (05) Lighting, sound signals.
 - (06) Communications (primary/secondary radio frequencies, times of status reports).
 - (07) Emergencies (breakaways, signals).
-

C.40. Deploying Drogue If drogue deployment is necessary, (i.e., to counteract a jammed rudder or other condition), the drogue should be deployed while barely making way before increasing speed to the planned towing speed (see [PART 1 CHAPTER 3 Section C Standard Towing Procedures](#) for more information).

C.41. Maintaining a Catenary Once underway with a tow astern, a proper length of towline should be maintained as discussed in [Combination of Forces and Shock-Load](#) of this chapter. Gravity causes a “dip” or downward sag (known as catenary) to form in the middle of the towline as it is lengthened. This catenary acts as a natural shock absorber for a tow rig and is a major factor in counteracting shock-loading ([Figure 3-15](#)).

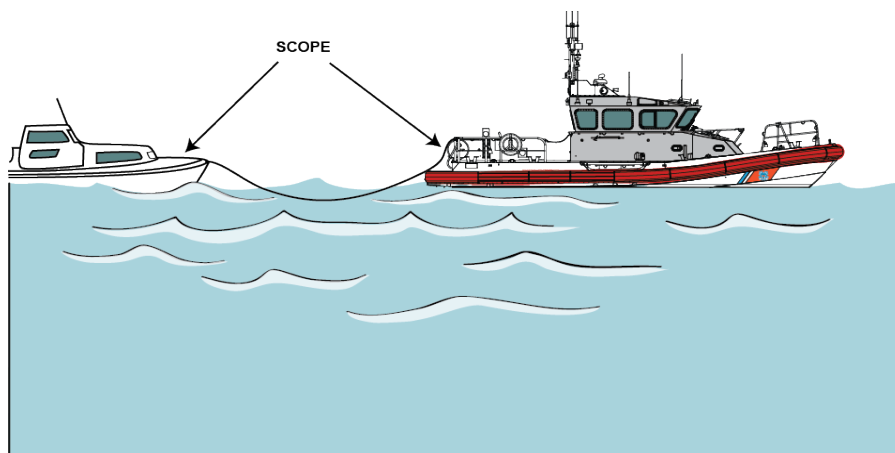

Figure 3-15
Scope of Towline with Catenary

C.42. Staying in Step

The tow should be kept in step at a proper distance behind the towing vessel. When the towing vessel is on a wave crest, the towed vessel should also be on a wave crest several waves astern.

If the towing vessel is riding up the back of a wave while the tow is sliding down the wave face, the towline slackens.

When the towing vessel starts to slide down the wave face into the trough, as the towed vessel starts to climb up the back of a wave, the towline becomes taut shock-loading the tow rig.

If an adjustment is not made, control of the tow may be lost. To prevent this from occurring, the towline scope should be increased to get the tow in step. An increase or decrease of your vessels speed may also help.

Other measures to consider include:

- (01) Altering course to increase the angle of the tow to the waves (to approximately 45°).
- (02) Deploying a drogue. In really confused seas, drogue deployment could help by preventing the towed vessel from surfing down the face of a wave.

Sometimes conditions make staying in step impossible. In such cases, the techniques above and reduction of speed should be used to counteract shock-loading.



C.43. Minimizing Yaw

The tow is said to yaw when it veers to one side or the other. Yaw can be caused by trim (including list, heeling or rolling, or by a bow-down attitude), rudder problems and wave action. Severe yawing is extremely dangerous and, if not corrected, may cause one or both vessels to capsize. Yawing also places tremendous strain on deck fittings and connections. Ways to reduce or minimize towed vessel yaw include:

- (01) Change towline scope.
- (02) Adjust trim (more easily done on a smaller vessel) to raise the bow or counteract list.
- (03) Decrease speed or alter course to reduce effect of waves and wind.
- (04) Deploy a drogue (particularly to overcome rudder problems).
- (05) Use a bridle.

Crewmembers should keep close watch on the action of the tow and immediately report any unusual movements to the coxswain. If yawing cannot be reduced or controlled, it may be prudent to heave to until sea conditions improve or the source of the yaw is corrected.

NOTE

Currents can cause a relatively constant or gradual offset of the towed vessel from the towing vessel's intended track or heading. Do not mistake this for yaw. (See "Compensating for Current," later in this chapter.)



C.44. Towing at a Safe Speed

A safe and comfortable towing speed maximizes towing efficiency. Damage, sinkings and loss of life have occurred as a direct result of towing too fast. Maximum safe towing speed is based on the vessel's waterline length and hull shape, but wind and sea conditions could dictate a much slower speed. The following formula shows how to calculate maximum safe towing speed:

- (01) S = Maximum towing speed (hull design speed)
- (02) Ss = Maximum safe towing speed
- (03) Lw = Square root of length at waterline
- (04) $S = 1.34 \times Lw$
- (05) $Ss = S - (10\% \times S)$ a 10% reduction in the maximum towing speed

For example, to determine a safe towing speed for a boat that has a 36-foot waterline length, the following calculations apply:

- (06) $S = 1.34 \times Lw$
- (07) $S = 1.34 \times (\text{square root of } 36)$
- (08) $S = 1.34 \times 6$
- (09) $S = 8.0 \text{ knots}$
- (10) $Ss = 8.0 - (.1 \times 8.0)$
- (11) $Ss = 8.0 - .8$
- (12) $Ss = 7.2 \text{ knots}$

If it is possible to tow fast enough to get the vessel up to the maximum towing speed (hull design speed), the strain and stress of the tow can be reduced for both vessels. Often, due to weather, seas, and other conditions, a hull will not be able to be towed fast enough to take advantage of its design.

While it is tempting to tow some vessels at higher speeds, in most cases – after performing risk management and factoring in conditions such as weather, seas, boating traffic and safe speed – it is recommended to tow all vessels using the safe towing speed calculation. **Table 3-1** lists the recommended maximum towing speed for all vessels.

WARNING

Due to safety concerns, never try to tow a hull faster than the hull design speed. Above hull speed, the vessel will try to ride up on its bow wave, becoming unstable and, in extreme cases, capsize. Also, wave drag (even one large wake) could slow the hull to displacement speed and cause a severe shock-load in the tow rig as the towing force tries to pull the towed vessel back on plane. In response to this shock-load, the towed vessel could plow its bow into another wave and swamp or capsize.

CAUTION !

Do not overlook the effects of wind and seas on determining safe towing speed. Though conditions can change during a long tow, be particularly careful when transition takes place in relatively protected waters. What may have been a safe speed during transition before could become dangerous for the towed vessel once it gets out of the lee of a headland, wharf, or large vessel.



NOTE 

Where and to what the tow rig is connected will also have an effect on the towing speed. Keeping in mind that the trailer eyebolt is usually a stronger connection than most deck fittings, a small craft may be towed at a greater speed if its trailer eyebolt is used instead of a weaker fitting up on deck. By connecting the towline to the eyebolt, the towline will pull the bow with more upward force compared with pulling the bow down if the tow is connected to a fitting on deck.

MAXIMUM TOWING SPEEDS					
DISPLACEMENT AND PLANING HULL VESSEL TOWING SPEEDS					
VESSEL'S WATERLINE LENGTH	SQUARE ROOT	MAXIMUM TOWING SPEED	VESSEL'S WATERLINE LENGTH	SQUARE ROOT	MAXIMUM TOWING SPEED
20	4.5	6 KNOTS	70	8.4	11.3 KNOTS
25	5.0	6.7	75	8.7	11.7
30	5.5	7.4	80	9.0	12.0
35	6.0	8.0	85	9.2	12.3
40	6.3	8.4	90	9.5	13.0
45	7.0	9.4	95	9.8	13.1
50	7.1	9.5	100	10.0	13.4
55	7.4	9.9	105	10.3	13.8
60	7.8	10.5	110	10.5	14.1
65	8.1	10.8	115	11.0	14.7

Table 3-1
Maximum Towing Speeds

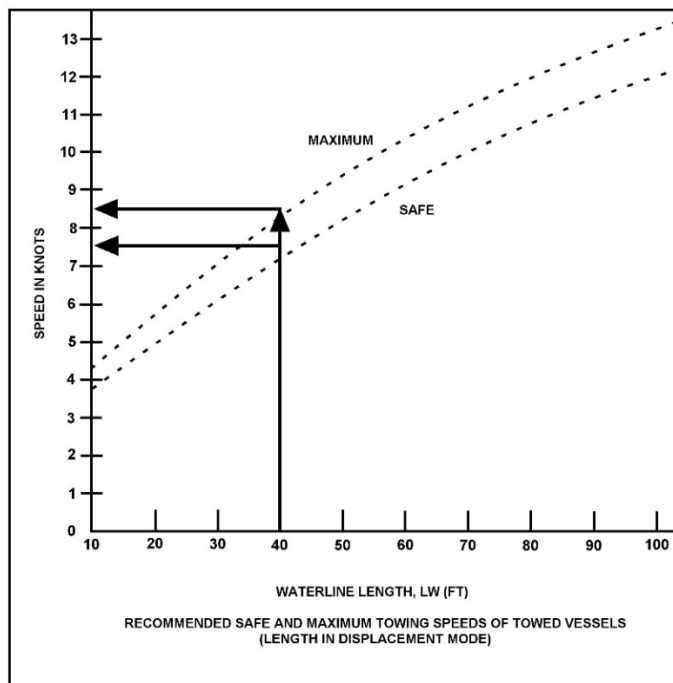

Figure 3-16
Calculated Safe Towing Speeds



Compensating for Current

C.45. Description

Handling a tow becomes more of a challenge when traveling in a river, estuary or other area where tidal currents affect navigation or in areas where major coastal currents or wind-driven currents come into play. This is particularly true near inlets, bars, river mouths, river bends, and areas where currents diverge or converge. Generally, there are four conditions encountered while towing in current:

- (01) Head current,
- (02) Tail current,
- (03) Cross current,
- (04) Combinations of currents.

To effectively deal with any of these, the towing vessel as well as the towed vessel must be navigated. One way to do this is to look at a stern tow as a single long vessel, with the propeller(s) and rudder(s) at the bow, and the pivot point at the stern. Though not a totally accurate picture, it shows that just because the towing vessel (the bow) changes direction, the towed vessel (the stern) will not immediately and automatically follow. Momentum will try to keep the towed vessel going in the original direction. Also, though the crew may frequently “crab” against the current with the towing vessel alone, now they must crab a vessel that becomes longer than the towline.

“Local knowledge” becomes extremely important when dealing with current. The effect of current on vessel navigation at 12-30 knots is far less than the effect while towing at 6-8 knots.

NOTE

Keep overall tow length in mind. In current, even though the towing vessel may be well clear of obstructions or buoys, the tow rig and towed vessel may be set into them.



C.46. Head Current

Head current is a current flowing directly against the steered course. Depending on the velocity of the current and the speed of the tow, speed over the ground may be reduced, stopped, or even reversed (**Figure 3-17**).

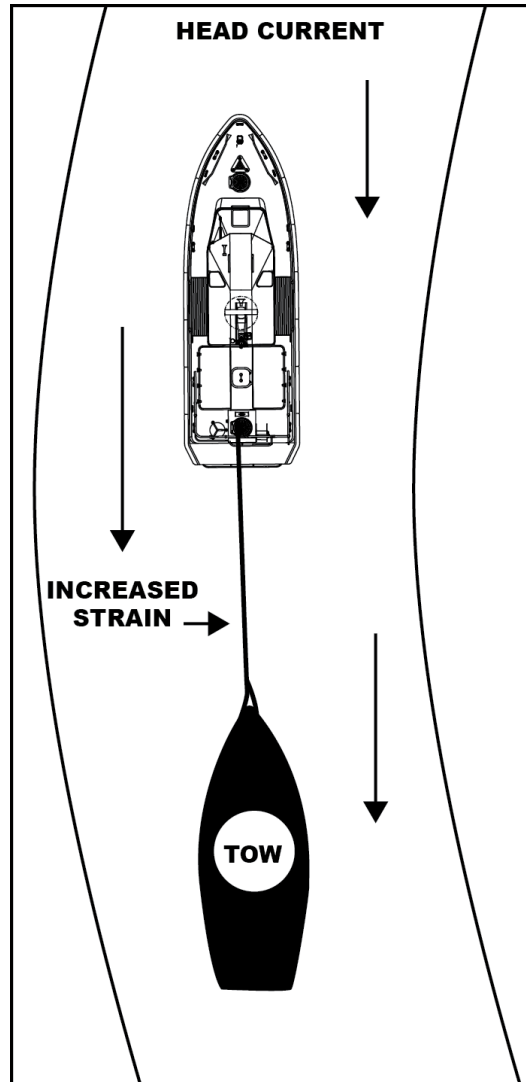

Figure 3-17
Head Current

CAUTION !

Regardless of speed over the ground, the tow is still moving through the water. Safe towing speed is based on speed through the water. Avoid towing a vessel above its hull speed or exceed the safe limits imposed by wind and sea conditions. If the current opposes winds and seas, the seas get steeper and break more readily. Increasing the speed through the water places excessive strain on a tow rig and deck fittings. Dynamic forces are still at work.



C.46.a. Narrow and Straight Waterways

A head current in a “narrow” waterway poses other concerns. In a perfectly straight waterway, shallower water outside a deep channel will provide some relief, provided that the tow remains in deep enough water for safe navigation.

CAUTION !

Make sure that both the towing vessel and the tow stay in water deep enough so neither vessel grounds.

C.46.b. Bends and Turns

When towing in a waterway with bends and turns, the greatest current will be to the outside of the bend or turn. Accordingly, the water will be deepest on the outside. When towing around a bend, the direction of the head current acting on the towing vessel may differ from that on the towed vessel. At a bend, the towed vessel may sheer (or yaw) to the outside of the bend. In these situations, the following procedures apply:

Step	Procedure
1	To deal with a very strong head current, consider waiting for the current to slacken, waiting offshore for tidal conditions to change, or changing destination. Also, if possible, find an area out of the main current flow to make progress.
2	Determine conditions in the river prior to entering. It may be prudent to remain in open water until currents slacken or tidal conditions change.

NOTE

Prevent towed vessel sheer by reducing towline length before entering narrower sections of a waterway.



C.47. Tail Current

Tail current is a current flowing in the same direction as the course steered. Crewmembers should remain aware of how the influence of a tail current affects both vessels. As with the head current, in general, speed through the water indicates appropriate handling procedures, not speed over the ground (see [Figure 3-18](#)).

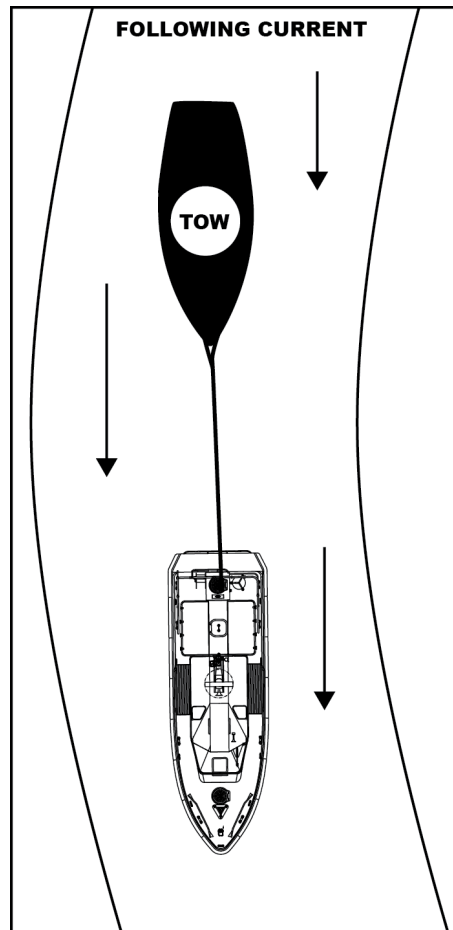

Figure 3-18
Tail Current

C.47.a. Open Water

In open water, a tail current usually helps the tow along. However, when opposing the wind or seas, the tail current causes steeper waves. The steeper waves may require slowing the towing speed. The tail current should be accounted for when estimating the time of arrival. All course changes or shortening-up of the tow must be done earlier, or the current will carry the tow past the desired point. Then, considerable effort will be needed to go back against the (now) head current.

NOTE

Compensate for a tail current by taking early action.



C.47.b. Narrow Waterway

As with a head current, a tail current in a narrow waterway also affects how the tow handles. A common situation develops when the towing vessel gets into an area of lesser current than the towed vessel. This often occurs near turns and bends where it appears that the shortest distance is on the inside of the bend. If there is a significant difference in the current, the tow sheers off along the axis of the current. This will possibly cause slack in the tow rig, loss of firm control, and will potentially overrun the towing vessel. To prevent this from occurring, the following procedures apply:

Step	Procedure
1	Minimize the possibility of loss of control in a tail current by staying in the same velocity of current as the tow. As with a head current, one way to do this is by shortening scope of the towline.
2	If a tail current looks as if it will become unmanageable, it may be necessary to change course and steer more into the current.

C.48. Cross Current

A cross current is a current that is flowing from either side, across the intended track. This current will require the towing vessel to adjust heading for set and drift for both vessels. At a towing speed of 7 knots, a 2-knot cross current will require a heading offset of over 15° in order to follow the intended track. In open water, this may not pose a problem, if the towing vessel adjusts properly throughout the tow (**Figure 3-19**).

In restricted waters, suddenly encountering a cross current, such as where a longshore current crosses a harbor entrance channel, could first cause the tow to appear to veer, even though the towing vessel is the one being affected. Then, when the towed vessel encounters the flow, it will appear to veer the other way.

In restricted waters, the towing vessel must adjust accordingly for the amount the cross current offsets the towed vessel from the intended track. The cross current could push the towed vessel into danger. The possibility of a cross current pushing the towed vessel into danger can be minimized through a combination of shortening tow and offsetting the towing vessel's intended track in an up-current direction. Also, if the towed vessel is able, they should be instructed to steer into the current to compensate for the set.

As an example, if a cross-current moving from right to left is present near a channel entrance, the tow should be shortened before entering and the towing vessel should be lined up to the right of the channel centerline. If unable to shorten tow, get well off to the up-current side of the channel centerline.



WARNING 

While towing astern, if there is any crosscurrent in a channel marked by a navigational range, do not steer the towing vessel exactly on the range. Doing so could stand the towed vessel into danger on the down-current side of the channel. If the towed vessel has any problems such as steering or stability, keep the towed vessel in good water (usually the center of the channel, marked by the range). Use the towed vessel's crew to inform the towing vessel when they are the range. Remember, when taking a vessel in tow, the towing vessel becomes responsible for its safety.

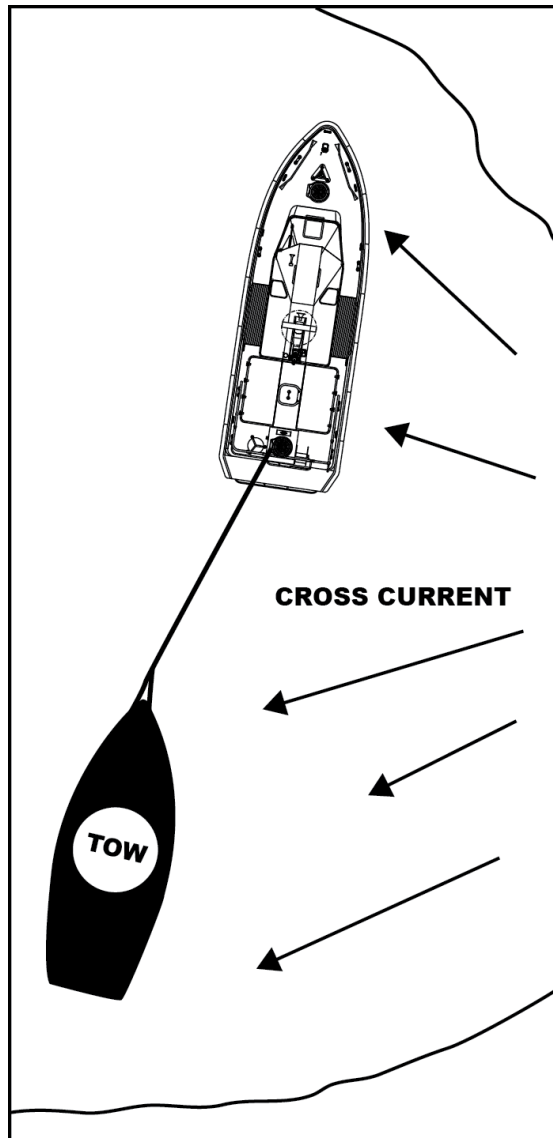

Figure 3-19
Effects of Cross Current



C.49.
Combinations of
Currents

Seldom will the current be dead on the bow, from directly astern, or exactly on the beam. If it happens to be that way at the moment, it may not be for very long. The marine environment is constantly changing, including the motion of currents. The general principles and specific procedures discussed above should be used to effectively compensate for combinations of currents.

The surface of the water should be closely watched for evidence of current changes. A “tide line” usually appears at the leading edge of a current change or marks the difference between two different flows. A river’s color changes because of flow from another river. “Tide-rips” or bar conditions vary with the amount of current. Close attention to how current flows past a fixed object (pier, bridge support, piling) or a buoy will provide a good idea of what direction the current is heading and how fast it is moving.

NOTE 

There is no substitute for experience and preparation. Learn the area of operations and be alert to hazards as to not be taken by surprise.

Shortening the Tow

C.50.
Description

When approaching safe haven, it may be necessary to shorten the towline to safely enter an inlet, cross a bar, tow in a channel, or turn into a basin. The tow should be shortened to increase control in confined areas and in current. The towline must be slack to shorten tow. The coxswain controls the amount of slack and the direction the towline tends while the crew recovers the towline. The crew and coxswain must communicate and coordinate their efforts and actions to make the task as easy as possible without fouling the tow vessel’s propellers, rudders or waterjets. Knowing your boat and its systems is important during the towline recovery. For example, if on a boat with propellers, Towline recovery should be kept on the beam or quarter to prevent the slack towline from fouling the propellers.



C.51. Before Shortening a Tow

The following procedures should be performed before shortening a tow:

Step	Procedure
1	Determine a safe area considering wind, depth of water, size of vessel, area to maneuver, current speed and direction, etc.
2	Determine the new desired towline length.
3	Brief the towed vessel's crew.
4	Brief own crew and assign tasks.
5	Reduce speed slowly and gradually to prevent the tow from closing too fast, and risking collision. Due to momentum, a vessel with greater displacement will keep way on longer than a light displacement vessel. A vessel with way on will stop more quickly when turned into the wind and seas.
6	As towline gets slack, direct crew to remove turns from the tow bitt. Crewmember at the bitt pulls slack so as to be ready to take a turn if necessary.



C.52. Shorten the Tow

The following are procedures describing how to shorten the tow:

Step	Procedure
1	As pivot begins, the coxswain directs the bitt person to break the bitt and a line handler must begin to pull in the towline. Recover towline and take it up on the tow reel (if equipped). Do not let bights of towline litter the deck or the crew working area.
2	The coxswain backs as necessary to slack the line, which allows the line handler to haul in the line more easily.
3	If the wind is any angle off the bow, ensure the towing vessel is blown away from the towline.
4	If the severity of the weather hampers control of the towing vessel, shorten the tow in segments. If an attempt to shorten must be aborted, the coxswain directs the bitt person to take a Working Turn and remove any slack. The crew must clear out between the bitt and the towed vessel before there is strain at the bitt. Make up the bitt if needed to hold the strain. The coxswain must then maneuver and restart the procedures.

CAUTION !

Do not back too quickly and cause a large bight in the towline that increases risk of fouling propellers, waterjets, or rudders. Backing too quickly may also create too much strain for the line handler if the towline bight leads too far forward.

Once a short tow is set, the “shock absorber” effect of catenary and scope is reduced. Special care should be used to counteract shock-loading.

NOTE 

In calm conditions, if not much towline was out to begin with, shortening a tow may not be necessary. It may be easier to go directly to an alongside tow.



**C.53.
Maintaining
Control in
Rough
Conditions**

When operating in rough conditions, the following procedures apply:

Step	Procedure
1	Turn into the weather with seas or wind (whichever is greatest influence on tow vessel motion) 30° to 40° off the bow.
2	If a lot of towline must be recovered, put the towing vessel's bow directly into the seas.
3	Whatever angle to the sea is chosen, pivot the towing vessel bow directly into the seas or wind whenever backing down to recover towline.
4	Crew communication and boat handling skills are paramount in this situation to avoid fouling the towline in the towing vessel's waterjets/propellers.

The greatest control occurs when the wind and seas are off the towing vessel's bow while on the beam of the tow. The wind and seas will drift the tow away from the towline.

Speed should be reduced to lessen the forces on the towed vessel, which in turn are transferred to the towing vessel.

Step	Procedure
5	In heavy weather, constantly adjust towing speed to prevent a tow from surfing on a wave or broaching.
6	If a large wave approaches the stern of a tow, increase tow vessel speed to keep ahead of the tow as it is pushed by the swell.
7	As a tow reaches the crest of a swell, reduce speed. Keep the towline taut. The coxswain must constantly watch the seas astern and the towed vessel until in sheltered waters.
8	Deploy the drogue.

NOTE 

This technique is very demanding and must be learned through training and experience. Throttle response (acceleration and deceleration) must be matched to the towed vessel's speed. If this technique is impractical to counteract shock-loading, speed reduction and quartering the seas may be your best options.



C.54.
Disconnecting
Tow or Towing
Alongside

At the safe haven, the towing vessel will either moor the towed vessel or disconnect the tow so the towed vessel can anchor or be assisted by other resources.

NOTE 

If disconnecting the tow, determine beforehand whether any other part of the rig will stay aboard the towed vessel. The weight of shackles or a wire-rope bridle will increase the difficulty of towline recovery, and could pose additional risk of fouling in propellers or rudders.

C.55.
Disconnecting
the Towline

The towline should be shortened up to some extent already. The towed vessel should be turned into the prevailing conditions for better control, making towline recovery easier and safer because there is less towline for the crew to recover and less towline in the water to foul propellers. It also allows the towing vessel to maintain control of a tow a little longer. Once shortened, and with the tow barely moving to allow the towline to slacken, the coxswain signals for the towed vessel crew to disconnect the rig and let it go into the water. The towing vessel crew then hauls it aboard.



Towing Alongside

C.56. Description

When set up properly, an alongside tow allows two vessels to be maneuvered as one. This advantage is necessary when approaching a dock, mooring, or anchorage in sheltered waters, or when maneuvering in congested or restricted waters. Most of the pre-tow procedures used for towing astern described earlier in the chapter remain valid. However, some additional preparations are needed and the make-up of the tow rig and approach will be different. The tow rig configuration and approach will be more like that for mooring (see [Figure 3-20](#)).

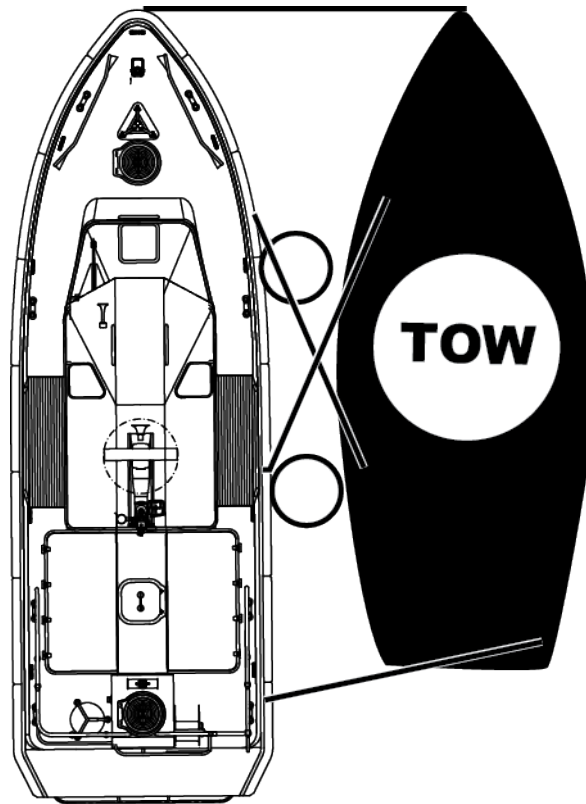

Figure 3-20
Side Tow



C.57.
Preparation

These following additional preparations apply for an alongside tow.

C.57.a.
 Determining
 Side of Tow and
 Approach

Step	Procedure
1	Determine on which side the tow will be rigged.
2	Note the effect of the weather and physical conditions on both vessels and use them to the fullest extent.
3	Although similar to a mooring approach, decide whether it is better to have the wind to set the towed vessel down on the towing vessel, or vice-versa.
4	Assess the other vessel’s drift rate and aspect to plan the speed and angle of your approach.
5	If a vessel smaller than the towing vessel is being rapidly set towards a lee shore or obstructions, consider approaching from leeward, if sea room allows.

WARNING 

Do not place the towing vessel between a larger towed vessel and a lee shore or obstruction. The towing vessel may not be able to overcome the other vessel’s momentum before losing all room to maneuver. As with any towing approach, leave an escape route.

C.57.b.
 Deciding Use of
 Towline

If the alongside tow occurs at the completion of a stern tow, the coxswain should decide if the towline will be disconnected from the stern tow (the Drop Tow method); or hauled in while still connected, and used as a bow line for the alongside rig (the Transition method).

If the stern tow required a bridle, Drop Tow may be the only option to provide a fair lead for the alongside bow line. One benefit of using Transition for an alongside tow is that there is always a separate bow line attached to the disabled vessel, and returning to a stern tow is possible, should the need arise.



C.57.c.
Preparing Lines

Crewmembers should make ready the proper size and number of lines to rig alongside, determining where the attachment points on the towed vessel will be for each line.

CAUTION !

Use of a towline as the bow line in an alongside tow leaves more line lying on deck and may be a tripping or fouling hazard.

C. 57.d.
Determining
Hull Match

Hull match is determined by assessing how the two hulls will align alongside. In towing alongside, the tow vessel may be angled, slightly bow-in to the towed vessel, with the towing vessel propeller(s) and rudder(s) aft of the towed vessel's transom, rudder, or outdrive(s).

C. 57.e. Rigging
Fenders

All available fenders should be rigged, except one for hand-tending as the tow approaches, in potential contact points. All fenders should be secured in place, using clove hitches or slip clove hitches, before bringing a tow alongside.

NOTE 

Keep all lines clear of the water.

C. 57.f. Briefing
Towed Vessel

The coxswain should brief the towed vessel as follows:

Step	Procedure
1	Advise which side to prepare.
2	If already in stern tow, describe shortening-up and whether towline will be used as bow line or whether (and when, "on signal") to cast off.
3	Describe approach and intended position alongside.
4	Direct the towed vessel to clear as many obstructions from the side as possible (rigging, lines, outriggers, etc.).
5	Direct the towed vessel to place fenders at obvious areas, such as trawler doors or topside vents.
6	Designate attachment points.
7	Direct crew how to assist.



C.58. Making the Approach

When making the approach, two alternatives are possible:

- (01) Transition approach,
- (02) Drop tow approach.

C.58.a.
Transition Approach

With towed vessel already in a stern tow, the following procedures apply:

Step	Procedure
1	Use the same methods as shortening the tow to take all headway off the tow before backing down. If the towed vessel has available propulsion, it may be able to assist by briefly backing down. If necessary, use the towline to change the heading of the towed vessel.
2	When the tow has stopped all forward movement, the coxswain directs the crew to “break the bitt.” The towing vessel slowly backs and the towline is hauled in.
3	Try to keep some space abeam until the towed vessel is in the proper fore and aft position.
4	As the distance between the vessels decreases and as directed by the coxswain, the crew walks the towline forward to a suitable bow fitting, takes a Working Turn on the line and takes in slack.
5	The coxswain then secures the towing vessel alongside the towed vessel.

NOTE

Show the towed vessel crew where to attach the alongside mooring lines. Perform all line handling at coxswain direction, just as in mooring. Always pass the eye of alongside lines to a towed vessel. Keep the working ends of the lines aboard the towing vessel to adjust or relocate as necessary.

C.58.b. Drop Tow Approach

The Drop Tow approach is made as if mooring to a pier, but the first line over will be the bow line. There will not be a spring line to check forward motion with respect to the towed vessel. The coxswain directs the crew to pass the bow line when alongside.

WARNING

Do not fend off boat with your feet or hands.

C.59. Rigging Additional Lines Alongside

Once alongside, with the bow line connected, the tow should be positioned so that the towing vessel’s propeller(s) and rudder(s) or waterjets are well aft of the towed vessel’s stern. This affords best control for maneuvering in confined areas. Fender placement should be checked and adjustments made so they provide maximum protection at contact points.



C.59.a. Calm
Conditions

If there is little or no movement from wind, seas or current, rig lines in accordance with the following procedures:

- (01) Rig a stern line from the towed vessel's stern to the towing vessel's stern. This line holds the sterns together while setting up the "spring lines".
- (02) Rig a "tow strap" (forward spring line) from the towing vessel bow or forward mooring fitting to a point aft of the beam on the towed vessel.
- (03) Rig a backing strap (aft spring line) from a quarter location on the towing vessel to a location forward of the beam on the towed vessel.

NOTE 

For maximum control of a tow, all alongside lines should be as tight as possible. Spring lines are tightened by crewmembers taking up slack obtained when the coxswain throttles *forward* and *reverse*, pulling first against the tow strap then backing down against the backing line.

C.59.b. Wind,
Seas, or Current

If conditions are setting the vessels into danger (e.g., toward shoals or breakwaters) with the bow line attached, and time is critical, use the following line procedures to secure lines alongside:

- (01) Rig a tow strap (forward spring line) so that once secured, the towing vessel can put headway on and move clear of any dangers.
- (02) With headway still on, rig a backing strap (aft spring line) and/or stern line. These will be needed to slow or control the towed vessel.

C.60.
Maneuvering

Maneuvering with an alongside tow is a challenging boat handling technique. To do it well and to do it safely requires practice and experience. An experienced coxswain will observe how winds, seas and current affect the combined tow and use these forces to the best advantage, often making the maneuver look easier than it really was.



C.60.a.
Approach for
Mooring

To moor an alongside tow safely and skilfully, perform the following procedures:

Step	Procedure
1	Anticipate well ahead of time and decrease speed gradually.
2	Place the larger vessel against the dock or mooring.
3	Making an approach into the wind and current if possible.
4	Moor on the protected (leeward) side of a dock or pier.
5	Place a crewmember in a good position as a lookout aboard a towed vessel on approach. This extends a coxswain's vision for clearances and obstructions.
6	Rig fenders and mooring lines from the tow if it is going to be placed against a dock or mooring.
7	The disabled vessel may use rudder control to assist in mooring, if practical.

Sinking Tows

C.61.
Description

When it becomes evident that a tow is about to sink, the situation should be very quickly assessed. Quick decisive action to minimize loss of life is the first priority. Once abandon ship procedures are initiated, radio communications will likely be lost. The primary action is to break the tow and rescue the people, either from the deck of the towed vessel or from the water.

A sinking tow can pull the stern of the towing vessel under unless all crewmembers pay close attention to the immediate situation. There might not be enough time to disconnect the towline from the towed vessel once it begins to sink.

If a tow begins to sink, all towing vessel headway is stopped. The force exerted through the towline increases the danger of the towed vessel yawing and capsizing. Every attempt should be made to have the towed vessel's crew disconnect the towline if possible and await rescue.

CAUTION !

Be aware that the boat could become fouled in rigging or debris while attempting to rescue survivors.



**C.62.
Minimizing the
Danger**

Perform the following procedures to minimize danger in sinking tow:

Step	Procedure
1	When it becomes obvious that sinking cannot be avoided, (e.g., the tow has rolled on one side and is not righting itself or the tow's decks are submerging) and the towed crew was not able to disconnect the tow rig, cut the towline or slip the towline by breaking the bitt.
2	Note the vessel's position by GPS, or radar fix and request assistance. Once free of the tow, make preparations to rescue people who were onboard.

WARNING  Do not attempt to break the bitt if there is a strain on the towline. Instead cut the towline using a knife. Cut towline directly aft of the tow bitt.

**C.63. Marking
the Wreck**

If there were no people onboard the tow, the water is shallow (depth less than towline length), and safety permits, the towline should be paid out until the tow reaches bottom. A fender or floatable object should be tied to the remaining towline so it is visible on the surface. The floating object will mark the location of the sunken vessel for salvage later as well as recovery of the towing vessel's towing equipment.

NOTE 

For further information, see Reference (v).



Section D. Towing in Heavy Weather

Introduction Heavy weather towing is one of the most hazardous missions that may be undertaken. Maneuvering close enough to pass a towline and then controlling that vessel while towing is dangerous for both crews and boats.

WARNING  Towing during heavy weather conditions is very demanding and must be learned through training and experience. Throttle response (acceleration and deceleration) must be matched to the towed vessel's speed.

In this Section This section contains the following information:

Title	See Page
Before Approach	3-77
Approach	3-78
Towing Procedures	3-82

Before Approach

D.1. Vessel to be Towed Circle the vessel, watch the vessel's movement (pitch, roll) in the seas and determine the effect of wind and current on the distressed vessel's drift rate and lateral movement. Compare it to your own drift. Knowing the different drift rates will help determine the best approach. Evaluate the location and any abnormal condition of deck fittings. Confirm the number of persons on board. Note any unusual conditions that may affect towing procedures (i.e., loose gear, rigging, or debris in the water). Communicate any concerns to the distressed vessel and direct all personnel on the distressed vessel to put on PFDs. Decide whether to put one of your crew aboard the distressed vessel. Decide if it is best to remove the crew from the distressed vessel. Determine if an equipment transfer (drogue, pump, radio) will be necessary. After evaluating the on-scene situation and assessing the risk, decide whether to tow or not.

NOTE  When conditions warrant, pass over emergency equipment, such as pumps or radios, before taking the vessel in tow.



D.2. Before Approaching

Before beginning the approach to the disabled vessel, the coxswain must ensure the crew and boat are prepared as follows:

Step	Procedure
1	Make engine room rounds prior to beginning the approach.
2	Disengage the auto pilot.
3	Ensure control of throttle.
4	Brief the crew and assign duties.
5	Check the towing rig.
6	Determine the danger zone.
7	Observe conditions and see how it affects control of the boat.

In heavy weather, it may be necessary to set up the deck underway at a slow speed to give the crew a safe, comfortable ride.

Approach

D.3. Towing Approaches

The towing approach requires maneuvering the boat close enough to the disabled boat, maintaining that position, and providing a stable platform long enough for the crew to safely pass the towing rig.

The towing approach in heavy weather is to set up down-swell of the disabled boat with the bow into the seas. When the crew is ready, the coxswain drives the boat into optimum position. It may be necessary to use more power than in calm conditions to get steerageway and make a straight-line approach. Conditions may require stopping below or above optimum position to pass a heaving line



**D.4. Approach
Determining
Factors**

Many factors are going to affect your decision on which towing approach to make. Some factors are discussed in the subparagraphs that follow.

D.4.a. The
Prevailing
Weather

In smaller sea conditions with strong winds, the stern to approach may be the better choice. In large seas or breaking seas, the bow to approach must be used to protect your crew.

D.4.b. Nature of
Distress

Depending on many factors, the Nature of Distress may affect your approach.

D.4.c. Type/Size
of Vessel

Size and configuration will greatly influence your towing approach. A large vessel with high freeboard at the bow may make passing a line to the bow difficult. Many commercial fishing vessels have stabilizing outriggers that must be left down in heavy weather to prevent loss of stability. Other challenges may include the skiff with a trailer eyebolt, a ferry boat, and crowded charter vessels to name a few.

D.4.d. Hazards

There are potential hazards in any towing evolution. Some serious potential problems that may affect your towing approach could be nets or lines in the water, rocks or shoals, outriggers and other gear, boat taking on water, logs and debris in the water.

D.4.e.
Coxswain's Skill
and Experience

Coxswains' skill and experience are going to greatly affect their decisions. No two coxswains will see the situation the same or make the exact same decisions in heavy weather.



D.5. Bow-to-Swell Approach

Bow must be kept square to the seas. By keeping your bow square into the sea conditions, you will maintain better control of your boat. This position gives you the safest approach, best visibility of your boat, your crew, the disabled boat, and the sea condition. Push ahead slowly without zigzagging from your down swell station keeping position and approach the disabled vessel.

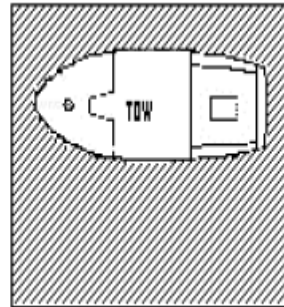
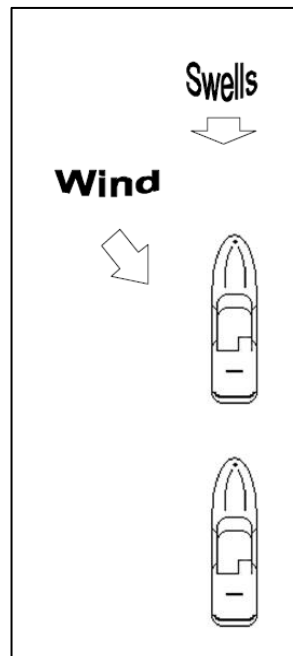

Figure 3-21
Bow-to-Swell Approach



D.6. Stern-to-Swell Approach

In heavy weather conditions, your crew may be exposed to waves coming over the gunwhales of the boat. This is extremely dangerous for your crew. Constant watch must be maintained when operating stern to to protect your crew and to safely pass the towline. Your vessels stern must be square into the predominate factor, this will allow you to maintain better control of your boat. Push ahead slowly without zigzagging from your up swell station keeping position and approach the disabled vessel.

NOTE

For operating parameters concerning stern-to-swell approaches, refer to the platform specific Boat Operators Handbook.

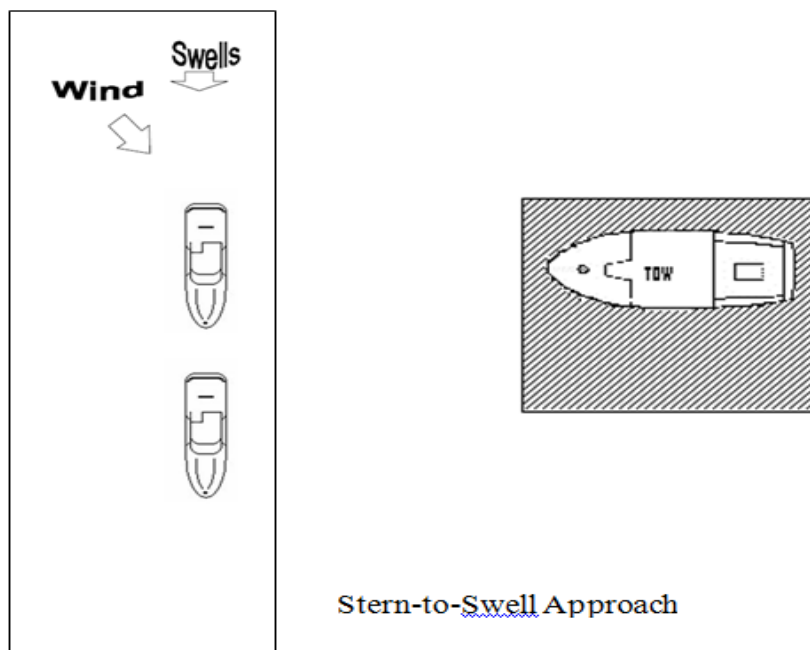

Stern-to-Swell Approach

Figure 3-22
Stern-to-Swell Approach



Towing Procedures

D.7. Passing the Towline in Heavy Weather

In a heavy weather environment you will first have to pass a heaving line. Once the heaving line is across, complete any maneuvers required and stop in optimum position. The coxswain has to determine when to pass the towline and give the command. Do not allow your crew to just send the line across before you give the command. On command from your crew, the crew of the disabled vessel hauls in the towline. Train your crew to ensure the line is attached to the disabled boat properly and will not come off the attachment point. If you are using a bridle, ensure it is attached to the boat on both sides for an even pull. There should be no turn on the bitt until coxswain gives the command. The coxswain ensures the bow is clear before giving the command to take a working turn on the bitt.

D.8. Working Turn

A working turn is a towline placed on a bitt that allows enough surface contact to ensure positive control of the towline. A working turn begins with a round turn placed on the bitt, and depending on the factors of the object being towed (e.g. size, weight, wind and seas) may require additional figure eights to effectively maintain control.



D.9. Towing Transition

Towing transition is the maneuver from station keeping to towing astern. This is the most hazardous period in heavy weather. You have to move from the safety of the maneuvering zone to put your tow behind you.

Take your time and don't maneuver away during the series. Transition is when you have the greatest likelihood of surging the towline through the bitt. The following are basic procedures for transitioning:

Step	Procedure
1	Communicate with your crew.
2	Take your time.
3	Start from Optimum Position.
4	Utilize the weather. Payout line quartering the swell or in the trough.
5	Get distance between you and the disabled vessel.
6	Leave the disabled vessel where it is while paying out towline.
7	Payout line providing the best ride for your crew.
8	On coxswain's command, make up the bitt.
9	Set a tow watch.

WARNING 

Risk from a running towline is greatly increased in heavy weather conditions. Great care must be taken to reduce surging the towline through the towing bitt as the boats separate and are affected by the seas.

WARNING 

Constant watch should be kept on the towed vessel and any change in trim or the way the vessel rides should be investigated immediately.



D.10. Towing Astern

In open water, getting both boats in step will also dramatically reduce the forces on the towed vessel. Changing course to reduce wave action is often the next safest technique. This will reduce the yawing and surfing of the towed vessel. Reducing speed or changing the scope of the towline will also lessen the forces on the towed vessel, which in turn are transferred to the towing vessel.

WARNING

Never allow the towed vessel to overtake the towline.

When approaching the coast, or nearing an inlet or bar, keeping the tow in step as water depth changes becomes very difficult. Plan to approach with seas on the quarter to reduce shock loading. The following technique should be used to maintain control and reduce the forces affecting of your tow:

- (01) Constantly adjust towing speed to prevent a tow from surfing on a wave or broaching.
- (02) If a large wave approaches the stern of a tow; increase towing vessel speed to keep ahead of the tow as it is pushed by the swell.
- (03) As a tow reaches the crest of a swell, reduce speed. Keep the towline taut.
- (04) The coxswain must constantly watch the seas astern and the towed vessel until in sheltered waters or course is changed to reduce influence of the seas.
- (05) Deploy the drogue.
- (06) Standing off shore and waiting for better conditions is the safest alternative if controlling the tow or the safety of the tow is in question.



Common Problems	Corrective Actions
Shock loading the towline	Adjust scope of towline, use a drogue, change course, adjust speed.
Vessel overtaking towline	Adjust scope of towline, use a drogue, change course, adjust speed.
Poor ride	Adjust scope of towline, use a drogue, change course, adjust speed.
Eliminate need to throttle jockey	Adjust scope of towline, use a drogue, change course, adjust speed.
Attachment point stress	Use a bridle, adjust scope of towline, use a drogue, change course, adjust speed.
Yawing	Use a bridle, use a drogue.

D.11. Towing in Following Seas

While towing in open waters, it is usually safer to change course to reduce the wave action. This will reduce the yawing and surfing of the towed vessel. Getting both boats in step will also dramatically reduce the forces on the towed vessel. Reducing speed or changing the scope of the towline will also lessen the forces on the towed vessel, which in turn are transferred to the towing vessel.

When approaching the coast, or nearing an inlet or bar, keeping the tow in step as water depth changes becomes very difficult. The coxswain should plan to approach with seas on the quarter to reduce shock-loading. The following techniques should be used to maintain control and reduce the forces affecting tow:

- (01) Constantly adjust towing speed to prevent a tow from surfing on a wave or broaching.
- (02) If a large wave approaches the stern of a tow, increase towing vessel speed to keep ahead of the tow as it is pushed by the swell.
- (03) As a tow reaches the crest of a swell, reduce speed.
- (04) Avoid shock-loading the towline. Keep the towline taut.
- (05) Constantly watch the seas astern and the towed vessel until in sheltered waters or course is changed to reduce influence of the seas.
- (06) Deploy the drogue.

Staying offshore and waiting for better sea conditions may be a safer alternative if controlling the tow or the safety of the tow is in question.



**D.12. Towing
into Heavy Seas**

Towing into heavy seas creates heavy strain on the towing vessel, the towing equipment, and the towed vessel. One of the most effective techniques to reduce strain is to reduce speed. Lengthening the towline and allowing a greater catenary will reduce the shock of the seas reducing chafing, stress on the towed vessel, and shockloading.

The placement of the towline on the bow affects the ride of the disabled vessel by pulling it down and often allowing seas to wash over its bow. This can be extremely hazardous to the disabled vessel and affect its stability. Reducing towing speed might help by raising the disabled vessel's bow and reducing the amount of water taken over the bow.

**D.13. Towing
Beam to the Seas**

Towing beam to heavy seas will reduce shock-loading and strain on the vessels but it increases the amount both vessels will roll in the seas. Great care should be taken when towing vessels with narrow beams or large liquid storage tanks. Narrow beam boats have less stability and are prone to capsizing. Vessels with large liquid storage tanks such as live wells may experience free surface effect that will greatly effect their stability. Free surface effect is the movement of a liquid (fuel, water) to one side of a partially filled storage tank as the vessel rolls from side to side. This shifting of weight is very dangerous to a vessel's stability.



D.14. Shortening Tow

Shortening the tow should be accomplished in open waters where there is plenty of room to maneuver. It is most often done prior to approaching an entrance to a harbor or river. By shortening the tow, control of the towed vessel will increase and make turning and maneuvering in tight quarters easier.

Before beginning, the coxswain takes up a course 10° to 15° off the seas with tow to windward. The wind should set the boat away from the towline. Speed is reduced until both vessels are stopped. This should set the boat up to put bow into the seas and have the towline off of the quarter. Once the bow is square, then the command is given to break the tow bitt. Keeping the bow square to the seas back and take in the amount of line required. It may be necessary to make more than one attempt to recover the line. Extreme care should be taken to prevent the towline from becoming fouled in the waterjets/propellers.

	<p align="center">Shortening Tow Procedures</p>
	<ol style="list-style-type: none"> 1. Notify your crew! 2. Take up a course approximately 10- to 15- degrees off the weather and seas. Move to the appropriate steering station. 3. Slow to all stop. 4. Push your bow square to the conditions (swell). 5. Give the command to break the tow bitt and end the towline. 6. Crewmember on aft deck hauls in line, crewman on tow bitt tends the slack through the horns of the tow bitt. 7. Back in a straight line rocking the throttles to keep square. 8. Divide your attention 80 percent aft - 20 percent on conditions/forward.



**D.15.
Precautions**

- (01) Crew Communications are extremely important. Ensure your crew can hear you and they understand their assignments.
- (02) Always tend the towline through the tow bitt. If you have an emergency, the crewmember can make the bitt and you can get underway again.
- (03) Keep towline in sight.
- (04) Know where your rudder is, use your Rudder Angle Indicator (RAI).
- (05) Make the bitt and pull ahead in case of emergency. This is your escape route.
- (06) Do not let the towline loop pass the recess. Excessive line in the water puts a heavy strain on your crew. Slow down and work at a pace your crew can recover the line.

**D.16. Emergency
Towing a
Disabled Boat
from the Surf**

Handling towing evolutions in surf is extremely hazardous. The danger involved limits this response to cases involving potential loss of life. Abandoned boats do not warrant the risk involved to boat crews or boats. Extreme caution must be taken when towing in surf conditions.

WARNING 

Towing in surf conditions requires specific techniques and should only be attempted when removal of the crew is more dangerous than the potential dangers from towing, whether to the disabled vessel or the towing vessel, or injury to personnel.



CHAPTER 4

Person-In-the-Water (PIW) Recovery

Introduction Every boat crewmember is responsible for identifying and managing risks. Operational mishaps can be prevented by honestly evaluating risks involved in every step of any evolution. Effective communication during all missions is essential to a successful mission completion. See reference (h), for additional risk management policy information.

All crewmembers must be prepared when someone falls overboard. Rehearsing how to react is vital to a successful and safe recovery of the individual. When someone falls overboard, crewmembers should always assume the worst has happened. The person could be suffering from shock, may be unconscious, and possibly injured. Rapid recovery of the person is a must.

This chapter addresses person-in-the-water (PIW) recovery procedures. Lives depend on every crewmember performing these procedures competently and effectively.

In this Chapter This chapter contains the following sections:

Section	Title	See Page
A	Recovery Methods	4-2



Section A. Recovery Methods

Introduction “MAN OVERBOARD!” is one of the worst alarms to hear while underway. Decisive action is of primary importance when a person falls overboard. Even the best swimmers can become disoriented when unexpectedly falling into the water. Prolonged exposure to rough seas or cold weather can quickly weaken a swimmer.

The information here is a general guideline. Actual situations will vary and all details pertaining to each are beyond the scope of this publication. A professional understands and rehearses each possibility remembering that the key to a successful rescue is preparation, practice, and alertness.

In this Section This section contains the following information:

Title	See Page
General Person-In-the-Water Procedure	4-2
Pick Up Methods	4-10
The Approach	4-10
Approaching in Low Visibility	4-14
Recovery	4-18

General Person-In-the-Water Procedure

A.1. Description The action taken in the first few seconds after a crewmember falls overboard decides the success of the recovery. An alert crewmember can do much to save the life of someone who might otherwise drown. First actions should be swift and certain.



A.2. Prevention

The first thing every crewmember needs to learn about recovering a person-in-the-water is how to prevent it in the first place. It is every crewmember’s responsibility to protect themselves and their fellow crewmembers from falling overboard. Some things to pay particular attention to are:

- (01) Ensure lifelines are up and in good condition.
- (02) Keep decks clear of trip/slip hazards.
- (03) Repair/replace cracked or damaged stanchions.
- (04) Ensure two persons are used when conducting an evolution that might result in falling overboard (anchoring, towing, etc.).
- (05) Ensure safety belts are worn during inclement weather.
- (06) Communicate changes in speed (COMING UP!) or direction (COMING TO PORT!).
- (07) When changing speed or direction, boat crewmembers are reminded to hold on (reference point) to the boat when possible. Remember: “One hand for you, one hand for the boat.”

Another important piece to the safety of the crew is ensuring that everyone onboard is wearing appropriate PPE. If someone should fall overboard, proper PPE will keep him or her afloat if unconscious, prolong exposure time in the water, and provide signalling devices that will assist rescuers in locating the person.

NOTE

More information concerning PPE can be found in BCH - Survival Procedures and Reference (n).

A.3. First Sighting

If a person enters the water, the first crewmember to realize that someone has fallen overboard should follow these procedures:

Step	Procedure
1	Spread the alarm in a loud voice by repeatedly calling out, “MAN OVERBOARD!” It is also very important to shout out the location the person fell overboard (port/starboard side, the bow, the stern) For example, if the person fell over the port side, the alarm should be, “MAN OVERBOARD, PORT SIDE!”
2	Maintain sight of, and continuously point (open handed) to the individual in the water while carefully moving to assigned position in sight of the coxswain or operator. Give clear, loud verbal directions as well as the condition of the PIW (conscious/unconscious, injured, etc.) to the coxswain.
3	Deploy a ring buoy with strobe light (or anything that floats) over the side as quickly as possible.



A.4. Coxswain or Operator Actions

Once the alarm has been sounded, the coxswain has several tasks to complete in order to successfully recover the PIW. Though a quick recovery is preferred, at times it is better to slow down, assess the situation, and ensure everything is done properly the first time. Not every PIW recovery is the same. It is always better to make a correct approach slowly and recover the person on the first attempt rather than an incorrect fast approach resulting in the need for a second try.

There is no single correct order in which the steps below should be executed. Everything depends on the situation at hand. Starting a turn to maneuver back to the PIW is a common first step, but if boat traffic in the area is heavy, turning the vessel might endanger others. Each task is important in its own way and needs to be conducted to ensure a successful recovery.

NOTE 

Remember...assess the situation before rushing to action!

WARNING 

Increasing speed during the recovery turn is not always the best maneuver! A sudden burst of speed or a rougher ride from going faster through the water can make for an unstable platform. Instead of just one person in the water, there could end up being more.

CAUTION !

Always operate at a safe speed!



A.5. Maneuvering Boat to Recover PIW

If someone falls overboard, the boat may have to be maneuvered for a pickup. In most cases, it starts by turning in the same direction the person fell overboard. Turning towards the same side the person fell overboard will “kick” the stern away preventing the propellers or waterjets from injuring the PIW. If the person falls off the bow, the turn should be in either direction to kick the stern clear. If the person falls off the stern, in some cases, the eddy current located off the transom can hold the PIW tight against the stern. Applying additional power while turning sharply to either port or starboard will push the PIW clear.

In some cases, turning the boat is not possible due to vessel traffic or a narrow channel. In these cases, slowing down and stopping are other options. Once the boat has stopped, the PIW may swim back towards the boat for recovery or after slowing to bare steerageway, spin the boat around and recover the PIW.

An increase in speed is not necessary during the turn. Recovering the PIW as soon as possible is important, but sometimes an increase in speed by the coxswain will catch the remaining crewmembers off guard and possibly eject them from the boat. If operating at high speed when the PIW takes place, it might be best to slow down before starting a maneuver. The coxswain should carry out the turn at a safe speed to ensure a more stable platform for the recovery crew.

A.6. Mark Position

Another important step is to record the boat’s position by pressing the appropriate button on the Chart Plotter/GPS receiver to mark the exact position (datum) of the distress electronically. This will give a position to return to if unable to locate the PIW and start a search pattern.

All possible means must be used to identify the position (dead reckoning, visual landmarks, radar, etc.), if the vessel is not equipped with a Chart plotter/GPS receiver.

A.7. Alerting Boats in the General Vicinity

Sounding five or more short blasts on the sound signal, horn, or whistle alerts boats in the area that a danger exists (i.e., a PIW has occurred). Boats in the vicinity may not be aware of what the signal means but at least they will realize something unusual is happening.



A.8. Deploying a Flotation Device

Any time the “Man Overboard” alarm is sounded, the coxswain shall direct a crewmember to throw the ring buoy with strobe light or anything that floats over the side (see **Figure 4-1**). This flotation device will serve two purposes. First, the PIW may see the flotation device and be able to get to it increasing their chances of being located and providing additional flotation. Second, the ring buoy or any floating object thrown over the side (if a ring buoy is not available) serves as a reference point (datum) marking the general location of the incident and for maneuvering the boat during the search for the PIW.

NOTE *↪*

Datum should not normally be removed from the water until the PIW or search object is found. Time and position of datum deployment should be recorded. The longer datum is tracked, the more accurate the search area will be as time passes.

CAUTION !

Do not throw the floatable object(s) directly at the PIW. It could cause injury if it hits the individual.



Figure 4-1
Ring Buoy with Strobe/Throwable Device



A.9. Assigning Crew Duties

Upon hearing the initial “Man Overboard” alarm, the coxswain will assign duties to each crewmember as follows:

- (01) A pointer will be assigned to take a position normally used for that boat (if conditions permit). This will normally be the crewmember making the initial report. The pointer will maintain constant sight of the PIW and continually use their hand to indicate the location of the PIW. The pointer will also call out the physical condition of the PIW to affect an appropriate rescue attempt (conscious/unconscious, face up/face down).
- (02) A recovery/pick-up crewmember will be assigned to prepare a rescue heaving line to be used in retrieving the PIW. If the PIW is reported to be unconscious, the recovery/pick-up crewmember will assist in dressing out and tending the boat swimmer.
- (03) The coxswain will assign a crewmember to deploy a ring buoy. If at anytime the PIW can no longer be seen, the recovery/pick-up crewmember will be instructed to deploy a ring buoy with strobe light (or anything that floats) over the side

A boat swimmer will be made ready if needed, as well as another crewmember on the tending line(if applicable) to the boat swimmer’s safety harness, whenever the swimmer is in the water.

NOTE

Review paragraph [A.30. Boat Swimmer Deployment](#) of this chapter for important information regarding boat swimmers.

A.9.a. The Pointer

The pointer will visually search for the person overboard, and when located, will point to the person overboard at all times. The coxswain will guide on the pointer’s hand signals in maneuvering the boat for the recovery approach.

The coxswain should ensure that the pointer is relieved of any other duties that could be distracting.

A.10. Crew Briefing

When the coxswain is ready to commence the recovery approach, he/she must brief the crew on how the recovery will be made, direct or indirect, and whether it will be accomplished on the port or starboard side. The approach will be influenced by:

- (01) Wind,
- (02) Sea/surf conditions,
- (03) Maneuverability of the boat,
- (04) Maneuvering space restriction.



**A.11.
Informing the
Operational
Commander**

When circumstances and time permit, the coxswain must notify the Operational Commander of the person-in-the-water situation. This should be done as soon as possible after the occurrence.

**A.12. Urgent
Marine
Information
Broadcasts
(UMIB)**

If the person overboard has not been located and immediately recovered and assistance of other boats is needed, the emergency call signal Pan (pronounced *pahn*) should be transmitted in sets of two for three sets (PAN-PAN...PAN-PAN...PAN-PAN) on channel 16 or 2182 kHz. This should be followed with the boat's identification, position, and a brief description of the situation. "Mayday" shall not be used. A boat uses a mayday call only when threatened by grave and imminent danger. After returning to datum and completing a quick scan of the area, if the PIW is not found, a datum marker (if one was not dropped initially) should be dropped and a search pattern commenced. The search should be continued until otherwise directed by the Operational Commander. More information concerning search patterns can be found in Reference (j).

**A.13.
Requesting
Additional
Assistance**

Requests for additional assistance may be made by radio or other means of communication.



**A.14.
 Summary**

The general PIW recovery procedures described below apply when an individual falls overboard from any boat. These procedures are in a sequence as it occurs in time:

Step	Procedure
1	Someone falls overboard.
2	The first crewmember to observe the incident calls out “MAN OVERBOARD” and follows this exclamation with the side from which the event occurred or the person was sighted, e.g., “Starboard side!”; then maintains sight of and continuously points to the individual in the water.
3	<p>Coxswain will perform the following tasks. The order depends on the situation at hand. Remember - slow down, assess the situation, and take action.</p> <ul style="list-style-type: none"> (01) The coxswain turns the boat in the direction indicated in the alarm. Coxswain maintains a safe speed to ensure crew safety while setting up for recovery. (02) Position is recorded by depressing the GPS receiver Save button (if this equipment is on the boat). (03) Alert boats in the general vicinity by sounding 5 or more short blasts on whistle or horn. (04) Direct a crewmember to deploy a ring buoy with strobe light (or anything that floats) over the side as quickly as possible.
4	<p>The coxswain assigns crewmember duties:</p> <ul style="list-style-type: none"> (01) The pointer (or first person to see the member go overboard) moves to a designated location for their boat, e.g., near a pilothouse window (weather permitting), locates the person overboard, and points to the location of the person at all times. <p>NOTE  Coxswain may relieve pointer of their duties when they have the PIW within sight, so the pointer may shift to recovery.</p> <ul style="list-style-type: none"> (02) The recovery crewmember makes preparation for the pickup.
5	The coxswain makes the recovery approach, briefs the crew on the recovery procedure including which side of the boat the pick-up will occur. Based on existing conditions, the coxswain will select either a leeward or a windward approach with a direct or indirect method.
6	As soon as circumstances permit, coxswain informs the unit of the situation.
7	If additional assistance is required, request help from Operational Commander and boats in the vicinity. Issue “UMIB” broadcast.



Pick Up Methods

A.15. The two most common methods for recovering a PIW are:

Description

- (01) Direct,
- (02) Indirect.

**A.15.a Direct
Pick Up**

The direct pick up method involves the boat's maneuvering in order for the crew to directly recover the PIW on deck – without the use of a rescue heaving line or boat hook. The direct method is usually used when the conditions are calm and the PIW is unconscious.

**A.15.b Indirect
Pickup**

The indirect pickup method requires the boat to deploy a boat swimmer, or a crewmember to pass a line (rescue heaving line, mooring line, etc.) to the PIW. Once the line is passed to the PIW, the PIW can be safely pulled into the boat. The indirect method is usually used when sea conditions make maneuvering close to the PIW unsafe and only when the PIW is conscious.

The Approach

A.16.

Description

The coxswain must select an approach that is suitable for the existing conditions. There are two basic approaches:

- (01) A leeward approach (against the wind and current),
- (02) A windward approach (into the wind and current).

WARNING 

If the PIW does drift aft of the boat, do not back down to effect the recovery. The propeller/waterjets could injure the person.



A.17. Leeward Approach

The leeward approach is performed with the bow facing into the greatest force of oncoming resistance at the time of pickup using the following procedures (see [Figure 4-2](#)). This may be the wind, current, seas, or any combination of the three. There are times when the wind and current are from different directions.

Step	Procedure
1	Select the heading that will best ease the approach, and balance the effect of any swells that might be present.
2	Make the approach rapidly, but as the boat nears the person, reduce wake and slow the boat enough to stop headway with a short backing down burst. The PIW should be next to the recovery area on the boat and the boat should be DIW.
3	Place the engines in <i>neutral</i> and, when the person overboard is alongside, have a crewmember make the recovery.
4	For better control during the approach, try to make all pick-ups with your boat heading into the prevailing weather and sea conditions.
5	Take care not to overrun the person overboard or to have so much headway on that the boat drifts beyond the person overboard.
6	If the PIW does drift aft of the boat, do not back down to effect the recovery. The propeller /waterjets could injure the person. The best course of action should the boat over shoot the PIW is to swing around and make another approach. It is best to make one correct approach slowly than several attempts quickly.

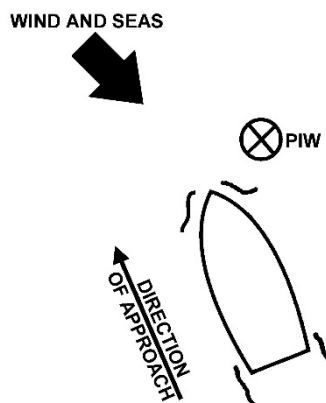

Figure 4-2
 Leeward Approach



**A.18.
Windward
Approach**

The windward approach (see **Figure 4-3**) is performed with the wind coming from behind the boat, when the person overboard is in a confined space, and a leeward approach is impossible. However, a situation where the boat cannot turn into the wind due to superstructure or bow sail area should be avoided. The following procedures should be used for a windward approach:

Step	Procedure
1	The operator must maneuver into a position upwind and up current from the person overboard.
2	Place the engine in neutral.
3	Drift down to the person.
4	Ensure that the boat drifts so it places the person overboard along the “recovery” side, but do not allow the boat to drift over the person.

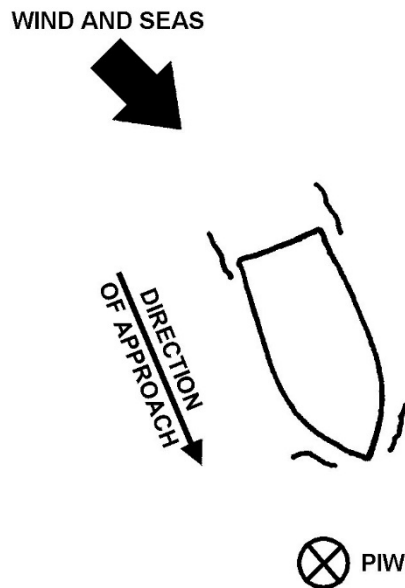

**Figure 4-3
Windward Approach**



A.19. Windward to Leeward of Multiple PIWs

Depending upon skill and experience, a combination of the windward and leeward approaches may be necessary. One instance may be in the case of recovering multiple PIWs (see [Figure 4-4](#)).

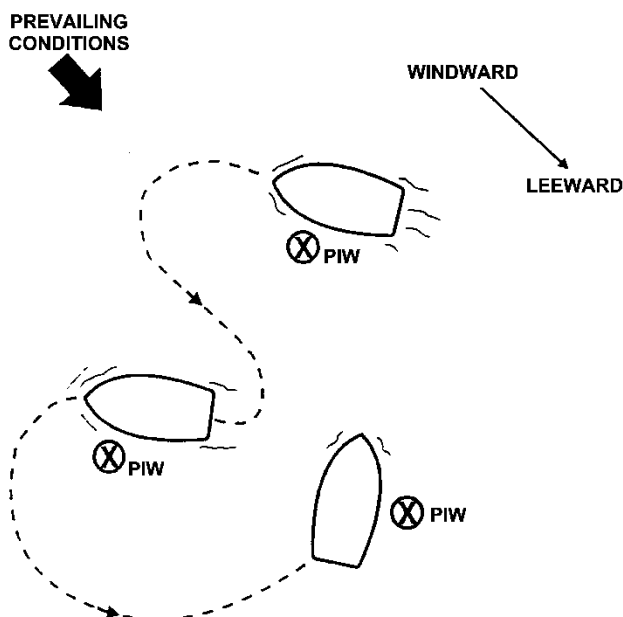

Figure 4-4
Windward to Leeward Approach of Multiple PIWs

A.20. Stopping Immediately

There may be instances when stopping the boat and allowing the person overboard to swim back to the boat, or at least to reach the tethered floating object, is the most appropriate action. This is effective especially if the boat can be stopped quickly after the person falls overboard. The coxswain should always ensure propellers/waterjets are not engaged anytime someone is in the water near the stern of the vessel.

A.21. Slow/Stop, Turn/Pivot Return

Another option, particularly in a restricted waterway, is to slow or stop, then turn or pivot, then return to the PIW. The turning and backing characteristics of the boat and the prevailing wind and sea conditions will dictate how the approach is made. The coxswain will maneuver the boat to the weather side of the PIW so that the boat is set by the wind or seas toward the person rather than away. In all cases of turning to recover a PIW, it should be completed safely and with due regard to the crew and prevailing conditions.

WARNING

Never have the propeller turning when the person overboard is next to the boat. If it is necessary to add power and maneuver with the PIW in close proximity to the boat, turn the bow toward the person, swinging the stern and propeller(s) / waterjet(s) away and at a safe distance.



Approaching in Low Visibility

A.22. Description

During low visibility and night operations, when a crewmember sees another person go over the side, the same general procedures apply. The crewmember seeing the person go overboard shouts, “MAN OVERBOARD!” Coxswain should direct the deployment of a flotation device with strobe (or any other light) attached, if available. They also continue to observe and point to the person overboard as long as possible. The coxswain presses the Save button on the GPS receiver, if so equipped, sounds signals, and goes to the datum using a safely executed turn and approach.

A.23. Williamson Turn

If an individual falls overboard during periods of darkness or restricted visibility, and the exact time of the incident is unknown, use of an installed chart plotter with trackline history can assist in bringing the boat back to a reciprocal course but if the trackline is not enabled or no chart plotter is onboard, a maneuver known as the Williamson turn should be used to search for the person overboard. The advantage of the Williamson turn, when properly executed, is that it will position the boat on a reciprocal course from your original track. This allows the search to commence on the track where the victim fell over, not from a parallel track. Of course, as soon as the alarm is spread the general person overboard procedures will be initiated.



A.23.a.
Procedure

The Williamson turn is performed using the following procedures:

Step	Procedure
1	Mark the original course when the alarm was initially spread. Put over a ring buoy strobe or other float to work datum.
2	Alter the course 60° to port or starboard from the original course. It does not matter which direction is chosen. Naturally, if turning to starboard, 60° will have to be added to the original course to know when the correct number of degrees has been transited. If turning to port, the 60° will be subtracted from the initial course.
3	The turn is actually executed while the first two procedures are in progress. In this step, the reciprocal course must be calculated from the original course. That is to say, a new course which runs in the exact opposite direction (180°) from the original course must be figured.
4	Once the correct reciprocal has been calculated and the compass reaches the 60° mark after turning off the initial course, shift the rudder in the opposite direction from the 60° turn and come to the reciprocal course.



A.23.b.
Starboard Turn

Figure 4-5 shows how the Williamson turn would look if the 60° turn was to starboard. Point “A” represents the initial course and is illustrated as 000° . At Point B, the compass reads 060° . At this point, the reciprocal course (180°) has been figured. When the compass reaches the 060° mark, the rudder is shifted to the opposite direction (port) of the 60° turn and the boat comes around to the reciprocal. When the 180° course is marked, the boat will continue on this new course and if the person overboard has not been sighted by this time, the boat crew will conduct a search for the victim along this heading. If the individual is not located, the boat should proceed along the track to a point where the member was last known to be aboard. At this point a second datum marker (ring buoy, fender, etc.) is deployed.

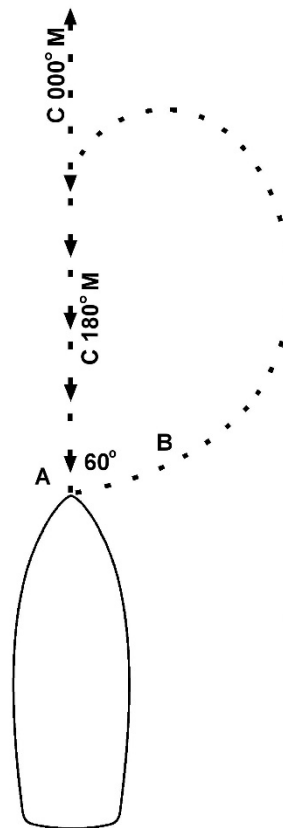

Figure 4-5
Williamson Turn

A.23.c.
Maintaining
Speed

Speed should not change during a Williamson turn. Any speed adjustments should be made prior to beginning the turn. Speed changes may bring the boat around to the reciprocal course in a different position than the line of the initial course. The danger is that the person overboard may be too far away to locate. The idea behind the Williamson turn is to bring the boat around so that it is on the exact line of the original course, but in the opposite direction.



A.23.d.
 Calculating the
 60° Turn

Once the person overboard alarm is spread, the coxswain turns the boat 60° from the original course to either port or starboard.

If...	Then...
The turn is to starboard,	The 60° must be ADDED to the original course: -Original course marked when alarm was sounded 080° -Starboard turn <u>+ 060°</u> -Shift rudder when compass reads 140°
The turn is to port,	The 60° must be SUBTRACTED from the original course: -Original course marked when alarm was sounded 080° -Port turn <u>- 060°</u> -Shift rudder when compass reads 020°

A.23.e.
 Calculating the
 Reciprocal of a
 Given Course

Calculating the reciprocal of a given course is done by either adding 180° to the given course or subtracting 180° from the given course. To add or to subtract depends on whether the given course was less than 180° or more than 180°.

A.23.f.
 Calculating the
 Reciprocal of a
 Course Less
 Than 180°

If the original course is less than 180°, 180° is added to the original course to get the reciprocal.

Example:

Original course	070°
Add 180°	<u>+ 180°</u>
Reciprocal course	250°

A.23.g.
 Calculating the
 Reciprocal of a
 Course More
 Than 180°

If the original course is more than 180°, 180° is subtracted from the original course to get the reciprocal.

Example:

Original course	200°
Subtract 180°	<u>- 180°</u>
Reciprocal course	020°



Recovery

A.24. Description

Recovery techniques for a PIW are the same for any type of distress. Situations could vary from recovering someone from the crew as a PIW, passengers from a ditched aircraft, fisherman from a sinking boat, someone washed off of a jetty, or any other form of emergency where people are in the water.

NOTE

Training boat crews for Person in the Water Recovery requires the use of a life-like dummy (OSCAR). The recommended OSCAR is a stuffed and weighted (approximately 180 lbs dry) Anti-Exposure Coverall secured at the neck and feet.

A.25. Recovery Methods

The condition of the PIW will dictate the type of recovery procedures used. Once the condition of the PIW can be determined, that is, conscious, unconscious, or injured, the coxswain will select one of the procedures below and assign crewmember duties accordingly. Generally, the pickup is completed at the lowest point of freeboard (recovery well) and away from the waterjets/propellers.

A.26. Person Overboard is Uninjured and Conscious

Perform the following recovery method when the person is conscious and able to move freely in the water:

Step	Procedure
1	Upon command of the coxswain, a crewmember casts out a heaving line or a float line to the PIW (Indirect).
2	The person will hold onto the line and be hauled in for recovery by the crewmember tending the line.
3	<p>If the person needs assistance to board the boat, position the victim facing the boat with both arms reaching upwards (Figure 4-6):</p> <ul style="list-style-type: none"> (01) The construction of some boats allows the rescue team to reach the victim at the surface of the water. If this is the case (Figure 4-7), two crewmembers pull the person up out of the water and onto the boat by each placing a hand under the person's armpit (use the other hand to hold onto the boat); or (02) When the platform does not allow the crew to reach the victim unassisted, a recovery strap/piece of line or a boarding ladder may be used if available.

CAUTION !

For both retrieval methods above, ensure the victim is facing the hull while being lifted, to prevent back injury.



Figure 4-6
Recovering the PIW at the Surface of the Water



Figure 4-7
Recovering a PIW Hands Under Armpits



**A.26.a.
Freeboard Too
High**

If the freeboard of the boat is too high to recover the victim safely, perform the following procedures:

Step	Procedure
1	Use a rescue strap/line under the armpits in a horse collar fashion (Figure 4-7).
2	The line should cross the chest, pass under each arm, and up behind the head.
3	Use padding for comfort, if available.

A person is light in the water due to buoyancy; however, once free from the water, the person becomes “dead weight.” This should be kept in mind and special care should be taken when recovering injured persons.

**A.27. PIW Is
Unconscious or
Injured**

In the event that the PIW is unconscious or injured, a direct pick up from the boat may be attempted if on scene conditions permit a safe recovery. If conditions are such that a direct pick up would be unsafe, utilizing a boat swimmer to recover the PIW should be considered.

CAUTION !

An untethered boat swimmer should be deployed only as a last resort! Once deployed, a coxswain has no means to retrieve the boat swimmer should they need assistance.

**A.28. Boat
Swimmer**

Boat swimmers are boat crewmembers who act to assist and recover fatigued, unconscious, entangled or injured survivors from the water. Their use may significantly reduce some of the dangers inherent in maneuvering rescue vessels close to survivors. They are not “rescue swimmers”. Their training is accomplished through completion of applicable tasks in Reference (b). A boat swimmer is assigned by the coxswain. Boat swimmers wear the appropriate PPE including a swimming harness with a tending line when available. Another crewmember will tend the harness whenever the swimmer is in the water.

WARNING 

Boat crews aboard platforms that do not have tending line and harness shall perform thorough Operational Risk Management (ORM) and exercise extreme caution before putting a swimmer in the water.

NOTE 

The Auxiliary does not have boat swimmers.

NOTE 

Policy regarding boat swimmers can be found in Reference (a).



**A.29. Tending
 Line Commands**

Communication between the crewmembers on the boat and the boat swimmer can be impacted as the distance between the two increase. To compensate, tending line commands are used to avoid the need for shouting. The signals primarily assist with communication but when used can also aid the boat swimmer in the recovery of a PIW. The signals are based on the **OATH** signaling system.

WARNING 

A Coast Guard boat swimmer shall NOT go under the water and enter a capsized or submerged object.

A.29.a. OATH
 Signaling System

Meaning	Tugs/Pulls	Swimmer Visual Signal
I am OK / Are you OK ?	One	Tap top of head
Advance	Two	One arm raised over head
Take in slack / I am ready to return to the boat	Three	One arm waving over head
Help / Do you need help?	Four	Two arms waving over head



A.30. Boat Swimmer Deployment

The procedures for deploying a boat swimmer are as follows:

Step	Procedure
1	The coxswain will designate one of the crewmembers as a boat swimmer.
2	The boat swimmer shall wear the boat swimmer harness (Figure 4-8) and tending line on all deployments from platforms equipped with this gear. Platforms that do not have a tending line and harness shall perform thorough Operational Risk Management (ORM) and exercise extreme caution before putting a swimmer in the water.
3	Enter the water feet first.
4	Swim/approach PIW pushing a ring buoy (do not attach strobe light).
5	When the boat swimmer has reached the unconscious or injured victim and has obtained a secure hold on the person (cross-shoulder position), the crewmember tending the harness line will haul both back to the boat (Figure 4-9).



Figure 4-8
Boat Swimmer Harness

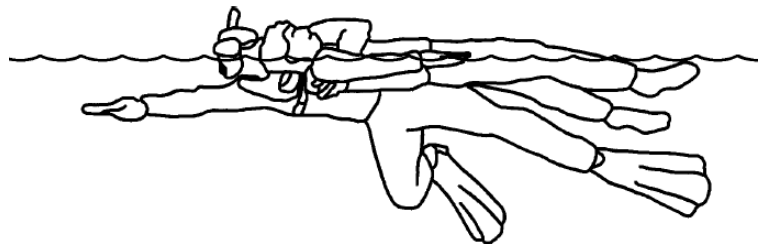

Figure 4-9
Cross-Shoulder Position



A.31. Stokes Litter

The stokes litter (rigid or folding) is a mobile transportation device designed to safely transport non-ambulatory personnel from the water, onboard ships and boats (Figure 4-10).

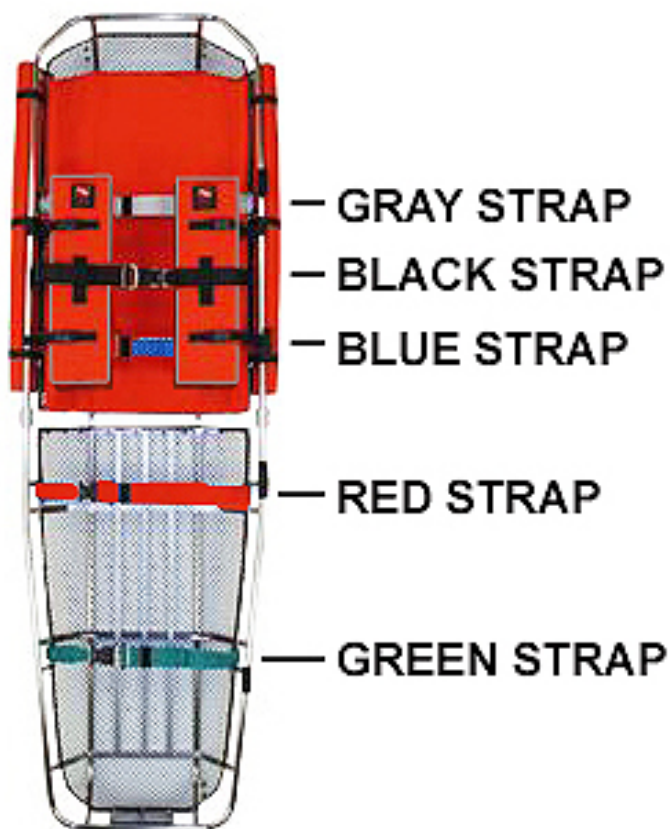

Figure 4-10
Stokes Litter

A.31.a. Application

The basic stokes litter can be configured for hoisting or surface operations. The unit type will determine which Stokes Litter is used (i.e. boat stations will use a surface stokes at a minimum, Air Stations will use a hoisting stokes and a cutter will use a surface stokes at a minimum).

Tending lines and hoisting sling cables shall be kept from interfering with patient restraint straps. The gray, black (flotation chest strap), blue, red, and green restraint straps shall be disconnected and secured to the right side of the litter prior to lowering the litter to the water's surface. The black restraint strap with flotation pads shall be buckled.



A.31.b.
Flotation
Characteristics

When the litter is configured in accordance with the MPC, it will float face-up at a 45-degree angle with the foot end submerged. The top 18 to 24 inches at the head end of the litter will be above the surface of the water. The stokes litter is self-righting.

WARNING

Patients wearing buoyant garments, such as exposure suits or PFDs, will affect and possibly negate the flotation and self-righting characteristics of the litter. Diligent attention to flotation characteristic changes when patients are secured in the litter.

WARNING

If the patient is secured to a backboard or spinal immobilization device, do not remove it.

NOTE

When securing the black restraint strap with flotation pads, difficulty may be encountered with patients wearing buoyant garments. Buoyant garments are not to be removed; instead place as much slack in the restraint strap as possible and attempt to connect the buckle.

A.31.c.
In-Water Patient
Restraint

Use the following procedure to secure a patient in the litter while in the water.

Step	Procedure
1	Disconnect the litter from the hoist hook, if used.
2	Disconnect the black restraint strap.
3	Guide the patient into the litter with a collar or equipment tow.
4	Pull the gray restraint strap loose from the right side of the litter and route it under the patient's arms and over the patient's chest. Connect the buckle pulling the slack from the strap.
5	Pull the red restraint strap loose from the right side of the litter and route it over the patient's arms and torso. Connect the buckle pulling the slack from the strap.
6	Secure the remaining restraint straps around the patient, working from head to toe, using the same procedure. Reconnect the litter to the hoist, if used.

WARNING

The in-water patient restraint procedure must be trained prior to use. Crew coordination between the swimmer and deck crew is critical to evolution success. Recurrent training of this procedure is highly recommended.

**A.32. Multiple
PIW Recovery**

For multiple PIWs, the question becomes which person in the water is recovered first. The answer to this requires the coxswain's best judgment. An accurate assessment once on scene will dictate the coxswain's response. Consideration should be given to the following:

- (01) Are one or more persons in the water injured?
- (02) Which persons in the water have on PFDs and which do not?
- (03) How close are the persons in the water to the beach or jetty?
- (04) How old are they and what is their physical condition?



Section B. PIW While Towing

Introduction If, during a towing evolution, a PIW emergency occurs, boat crewmembers should be aware of the severity and danger of the situation. Several problems can occur when dealing with a simultaneous towing and person-in-the-water situation.

WARNING Never make sharp turns when towing! Turns should be made in slow and small increments. Always try to keep the towed vessel almost directly astern.

In this Section This section contains the following information:

Title	See Page
PIW While Towing	4-25

PIW While Towing

B.1. Vessel When towing a boat astern:

Maneuverability

- (01) A decrease in speed could cause the towed boat to overrun the towing boat. If the towing boat slows and does not tend the towline, the towline could sink and foul the rudder/s and propeller/s or be sucked into the waterjets.
- (02) If the towing boat turns sharply to either side, tripping can occur. Tripping is when a boat is pulled sideways by an opposing force. If the towline is out of alignment (not in line) and pulls sideways, the towing boat will heel over, often beyond its ability to right itself.

CAUTION ! Tripping occurs more frequently when the towed vessel is larger or heavier than the towing boat.

B.1.a. Weather Conditions

Current, wind, sea, or swell from astern can cause yawing and add to the problem of the tow overrunning the towing boat. Current broadside to the tow creates difficulty in holding the tow due to side slip, causing the tow to yaw.

NOTE

Bar or inlet conditions will compound all these problems.

B.1.b. Pre-Planning

Considering the number of potential problems that can occur, the operator should carefully assess all possible situations and conditions to pre-plan steps to take in case of a PIW emergency.

CAUTION ! Slow calculated moves are better than a “knee jerk” response.



B.1.c. Additional Procedures

If a person falls overboard during a towing evolution, the initial steps discussed earlier in this section (sound alarm, throw ring buoy) should be followed. The following are additional considerations to take which apply to PIW situations specific to towing evolutions.

- (01) If another boat is nearby, get that boat to make the pickup.
- (02) Since tows are made at slow speeds, it may be possible that the towed boat can make the pickup. If the towed boat still has steerage, have them attempt to steer on the PIW and pick them up when alongside. The towing boat should aid in any way possible by slowing down or steering towards the side the PIW is located.
- (03) If towing astern, position a boat crew member to manage slack in towline and conduct slow speed turn to regain PIW off the bow. Make approach and recover from preferred side.
- (04) Be sure to advise the people on the tow that there is a real danger of tripping or broaching if the towed boat shears away violently from alignment.
- (05) Ensure the towline does not sink and become fouled around the rudder/s or propeller/s.
- (06) It might be necessary to drop the tow in order to perform a PIW operation. Consider the environmental factors and water traffic when/if dropping the tow to minimize the possibility of a hazardous situation. Have the tow anchor if possible until the towing vessel can return and continue the tow.
- (07) Never forget that the PIW might be injured if hit by the tow.
- (08) A person who has fallen off the bow or side can be seriously injured or killed by the waterjets/propellers. Any turns made should move the stern away from the PIW.

B.1.d. Person-in-the-Water from the Towed Vessel

If a person falls overboard from the boat being towed, the initial steps discussed earlier in this section (sound alarm, throw ring buoy) should be followed. If there is no other boat in the area to assist, dropping the tow to recover the PIW is an option for the coxswain to consider.

If the PIW takes place in restricted waters, the disabled vessel should be anchored as soon as the tow is released.

NOTE 

Always ensure everyone onboard the vessel being towed is wearing a PFD.



B.1.e. Towing
Alongside

When towing a boat alongside, the initial steps discussed earlier in this section (sound alarm, throw ring buoy) should be followed. Towing alongside allows more freedom to turn. Consider the following points:

- (01) Engines, while useful, will not respond as usual. Remember, the engines were designed to propel one boat, not two.
- (02) When making a turn, turn slowly towards the side with the tow and pivot on the tow. Be careful not to swamp the tow.
- (03) The best approach is to make the pickup on the free side since the operator can better observe the person in the water and the pickup.
- (04) Again, consider dropping the tow.

The procedures will remain the same, whether the person falls from the towed or towing vessel.

B.1.f. Summary

The effect of each action on all of the boats and persons involved should always be considered. People before property. People's safety is the number one priority. People onboard the vessel being towed are just as important as the PIW. If the towed boat is not manned, the coxswain may consider dropping the tow! All people and vessels involved should always be informed of every situation.

The best way to handle a PIW emergency is to prevent one from happening. Being aware of the crew; knowing where they are and what they're doing is essential.



Section C. Heavy Weather/Surf PIW Recovery

Introduction Recovering a person from the water in heavy weather/surf requires special precautions beyond the routine. It may be considered a given that a PIW evolution will bring the coxswain and crew to a higher sense of awareness. However, due to the increased risk of operating a boat in heavy weather conditions, special considerations must be given to the level of experience and skill of the boat crew and the capabilities of the boat. It is up to the coxswain, in most cases, to act as he or she sees fit.

CAUTION !

The Auxiliary is not authorized to operate in surf conditions.

NOTE 

If there is no discernible lull, it is prudent to remain at sea while waiting for bar conditions to improve (i.e., flood current).

In this Section This section contains the following information:

Title	See Page
Person-In-the-Water	4-28

Person-In-the-Water

C.1. PIW Procedure

The general PIW procedure is put in effect as soon as the alarm is sounded, but the nature of heavy weather/surf adds complications. The coxswain may be required to enter the heavy weather/surf by positioning the boat down swell of the PIW and making the approach as discussed in this section.

C.2. Down Swell Run

If needed, the turn to run down swell and approach will be planned differently in heavy weather/surf. The coxswain may not be able to turn the boat immediately after the alarm is given. Doing so may expose the bow of the boat to the swell enough that regaining control and getting the bow back into the seas might be very difficult.

The coxswain will push ahead a safe distance from the person in the water and station keep until the opportunity to turn presents itself. The turn is not made until the coxswain can do so without exposing the beam of the boat to the breaks or excessive swells. This is avoided by timing the turn to correspond with the lull in the breaks. Doing so allows the coxswain to take advantage of any window that may develop. Once the window has been identified, the coxswain turns, either port or starboard, using the techniques



described as the split throttle maneuver (Heavy Weather Turn). If the water depth allows, the coxswain continues down swell past the PIW. When passing at a safe distance, an assessment is made as to the condition of the PIW (i.e., conscious and face-up, unconscious and face-down); this will help decide how best to prepare for the final approach.

The split throttle maneuver (Heavy Weather Turn) is discussed in greater detail in Reference (k).

C.3. Spacing

While transiting down swell, you should turn your attention to crew communication, condition of PIW, and spacing of your vessel away from or toward the PIW. A properly executed heavy weather turn will advance the lifeboat approximately one boat length in the direction of the turn and this should be taken into consideration when passing the PIW while traveling down swell. Regardless of weather conditions but with due regard for safe navigation, you should attempt to stay within fifty to one hundred yards of the PIW.

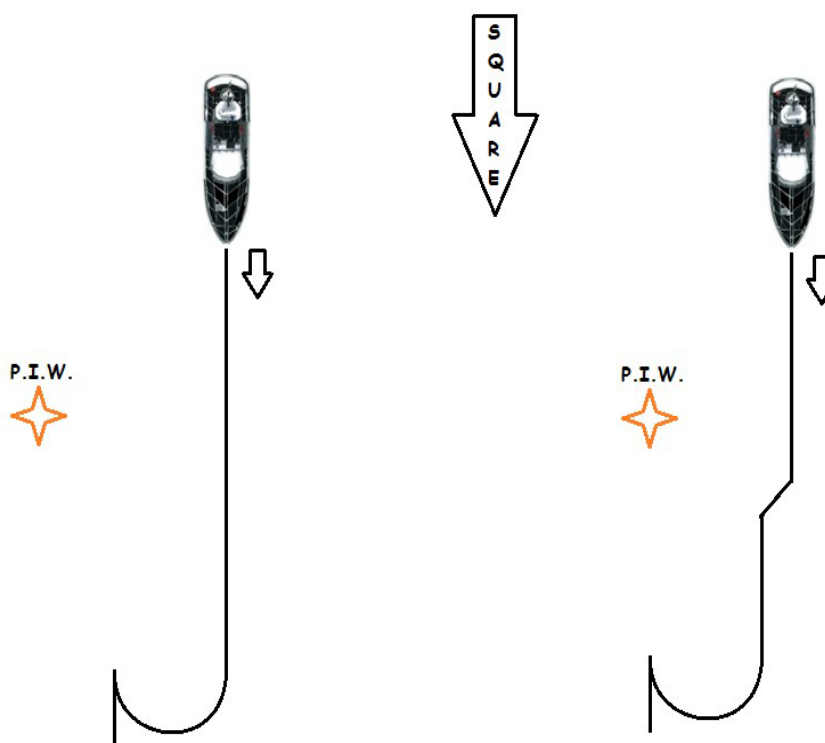

Figure 4-11
Spacing while Traveling Down Swell

WARNING

Initiating a Heavy Weather (Split Throttle) turn on the face of a steep wave can result in a knockdown/rollover and should be avoided at all costs. Reference (r) contains further discussion of the Split Throttle maneuver.



C.4. Approach

Once the run down swell is completed, the boat must be turned to make the approach. The turn should be made so as to simultaneously put the bow into the surf/swell and have the PIW directly in front of the boat, keeping in mind the turning radius of the boat and the effect strong winds may have, make adjustments as necessary. This may require some lateral movement down swell of the PIW. The pointer must be able to communicate with the coxswain at all times. Positioning the pointer by the open bridge is recommended.

Once down swell, the coxswain must turn the boat quickly and avoid getting caught broadside to the surf/swell. A break taken on the beam may roll the boat.

After completing the turn into the swell or breaks, forward momentum is stopped and, if practical, station keep is commenced by using references on the beach, jetty, and/or adjacent structures. Doing this will give you time to consider the following:

- (01) Boat position in relationship to the PIW.
- (02) Set and drift of both the boat and the PIW.
- (03) Wind direction.
- (04) Formation of a window/lull near the PIW.
- (05) Reestablishing crew responsibilities (if needed).
- (06) Sending a crewmember to the recovery area.

NOTE

On a CG standard boat, the crew must stay out of the recovery area until the turn is completed, the bow is back into the swell, and the coxswain gives the command.

WARNING

Do not allow any crew to go forward at any time during this evolution. It puts them in great danger and decreases the crew's ability to communicate.

C.5. The Recovery

When making the final approach, the coxswain must adjust the speed to avoid launching the boat off the back side of a wave. He/she should use the bow bitt or other stationary object on the bow as a sight and aim the boat at the PIW. Speed should be reduced to bare steerageway while nearing the PIW. This approach is made so that the PIW is not in danger of being struck by the boat. Timing is essential! If the coxswain is able, he/she should wait for a lull to make the approach.

The crew must keep the coxswain informed of the PIW's relationship to the boat at all times. This can be done by using reference points on the boat and calling distance off the hull.

WARNING

A breaking wave or steep swell can surf a PIW into the side of the boat or move them astern of it!



C.6. Recovery of a Conscious Person from the Water

Ideally, the boat should be stopped with the PIW at arm's length from the recovery area. This allows the crewmember to simply reach out and pull in the person for recovery. In the event the person is too far away to reach by hand, he or she may be able to swim or be tossed a rescue heaving line and pulled to the recovery area. All options must be considered, keeping in mind that a person suffering from hypothermia and/or exhaustion may not be able to assist when being pulled from the water. Also, using a rescue heaving line in the surf is very risky. The crewmember tending the line must remain alert to keep the line under control at all times, and advise the coxswain when the line is in the water. A decision to disengage the waterjets on the side of PIW should be weighed very carefully after considering the situation. This limits the maneuverability and power that may be needed.

C.7. Recovery of an Unconscious PIW

Recovery of an unconscious PIW from the surf presents an even greater challenge. Because the PIW is unable to swim or hold on to the rescue heaving line, the coxswain must maneuver the boat so that the PIW is taken alongside. Again, crew communication is critical. The coxswain must steer the boat straight for the PIW and as he or she begins to disappear under the bow flair, turn slightly to port or starboard (depending on which side is best for recovery), windward of the PIW if possible. At this point, the coxswain will lose sight of the PIW under the bow flair. It is now the pointer's responsibility to inform the coxswain of the location of the PIW, the distance off the hull, and how far the PIW is passing down the hull. When the pointer reports the PIW is approaching the recovery area, the coxswain should begin glancing down at the water, watching for the PIW to appear. When the PIW is in sight, the coxswain may need to make a final speed adjustment. Foam or bubbles passing down the hull can help determine the boat's speed. Having all way-off when the PIW is approaching the recovery area is important for two reasons:

- (01) It is very difficult to maintain a handhold on a person when the boat is still moving ahead.
- (02) Having to back down with the person near the recovery area is dangerous, and the discharge from backing down may push the person farther away from the boat. Again, slow down well before the person is at the recovery area.

To do this, the coxswain may back down on both engines or on the engine opposite the PIW. Backing down on the opposite engine will kick the recovery area toward the PIW. However, the coxswain must not allow the bow to fall off the swell. The use of the boat hook must not be ruled out if the PIW is too far away to retrieve by hand. It is better to use a boat hook and recover on the first approach than to back down or run stern to the surf/swell to make another approach. There may only be one chance to make the rescue – it has to be good!



WARNING 

Backing down must be done before the PIW gets to the recovery area so that the boat has no way on during recovery.

C.8. Use of a Boat Swimmer

Using a boat swimmer in heavy weather or surf is extremely dangerous and should only be used as a last resort. Having a member of the crew enter the water presents different problems:

- (01) Reducing crew size of an already minimal crew makes it difficult to retrieve the PIW.
- (02) The likelihood of the tending line becoming fouled in the jets/propeller is greatly increased.

C.9. Multiple PIWs

For multiple PIWs, the question becomes “which PIW is recovered first?” This is a hard question to answer and requires the coxswain’s best judgment. Once on scene, an accurate assessment will dictate the coxswain’s response. Consideration should be given to the following:

- (01) Are one or more PIWs injured?
- (02) Are PIWs wearing PFDs?
- (03) How close are the PIWs to the beach or jetty?
- (04) How old are the PIWs and what is their physical condition?

Using the above criteria may aid the coxswain in making this difficult decision.



CHAPTER 5

Rescue, Assistance, and Fire Fighting

Introduction

Every boat crewmember is responsible for identifying and managing risks. Operational mishaps can be prevented by honestly evaluating risks involved in every step of any evolution. Effective communication during all missions is essential to successful mission completion. Reference (h) contains additional risk management policy information.

As first responders boat crews have an important responsibility in maintaining their vessels and assisting those in distress. A primary responsibility of a boat crew is to save lives, not property. However, when and where possible, while managing risks, a boat crew will attempt to save property. Boat crewmembers may be called upon to react to a fire on their own boat or dewater vessels. This chapter discusses:

- (01) Safety and prevention measures to take when on a boat or assisting a distressed vessel.
- (02) How to assess emergency situations.
- (03) Several methods on how to right overturned vessels.
- (04) How to control flooding.
- (05) How to prevent, identify, and extinguish boat fires.
- (06) How to dewater vessels.

It is very important to keep in mind that any vessel can fall victim to tragedy when proper prevention measures or rescue procedures are not followed correctly and precisely.

In this Chapter

This chapter contains the following sections:

Section	Title	See Page
A	Safety and Damage Control	5-2
B	Flood Control and Dewatering	5-4
C	Fire Fighting	5-19
D	Fire Theory, Classifications, and Fuel Sources	5-24
E	Fire Fighting Equipment	5-26
F	Description and Application of Extinguishing Agents	5-35
G	Fire Fighting Procedures	5-46
H	Extinguishing Fires	5-52



Section A. Safety and Damage Control

Introduction Safety is paramount during all emergency evaluations that a member of a boat crew will be involved in. Mishaps resulting in death or injury have occurred when boat crews responded to vessels in distress. Nearly every mishap that resulted in serious injuries had a common denominator. Serious injuries happen when common sense and a continuing regard for safety give way to reckless urgency.

A boat crewmember’s primary responsibility in emergency assistance is saving lives, not property. Boat crews must be aware of their limited roles in emergency assistance, particularly when responding to fire emergencies. Safety begins with assessing primary responsibilities and capabilities for the variety of emergency situations encountered.

In this Section This section contains the following information:

Title	See Page
Safety Assessment and Management Guidelines	5-2

A.1. Safety Assessment and Management Guidelines

Emergency situations can cause people to panic or act before thinking despite the best of training and preparation. Therefore, boat crews must work together as a team to minimize any potential or immediate jeopardy for both civilian casualties and themselves. An emergency situation should never be entered without first:

- (01) Assessing the risk involved for the boat crewmembers and civilian victims (risk assessment).
- (02) Being aware of the dynamics of the emergency situation (situational awareness).
- (03) Implementing a control plan that fits each unique emergency (damage control risk management).

A.1.a. Risk Assessment

Risk assessment starts with realizing why mishaps occur. The responsibility for identifying and managing risk lies with every member of a boat crew. Realistic training based on standard techniques, critical analysis, and debriefing missions will help every person in a boat crew to contribute to developing and implementing a risk management plan. A risk management plan identifies and controls risk according to a set of preconceived parameters. Refer to Reference (h) for a complete discussion of risk assessment and risk management plans.



A.1.b.
Situational
Awareness

Situational awareness is an important skill to develop as part of learning risk assessment. Situational awareness is the accurate perception of factors and conditions affecting the boat crew at any given time during any evolution. More simply, situational awareness is knowing what is going on in the surrounding environment at all times.

Any time there is an indication that situational awareness is about to be lost, a decision must be made as to whether or not to continue with the rescue attempt. Everyone in the crew owns some responsibility for making these important decisions. These decisions take the form of action/reaction and communication.

NOTE 

Crews who have a high level of situational awareness perform in a safe manner.

A.1.c. Damage
Control Risk
Management

The precautions listed below include many of the considerations that can form a basis for a general damage control risk management plan. Boat crews should keep in mind that each emergency situation will be unique; therefore the plan must only be used as a general guideline. The experience and knowledge of each boat crew should be merged into a risk management plan and used to fine-tune this list.

- (01) Attempt to account for all persons.
- (02) Ensure all persons onboard the vessel in distress have donned PFDs, if possible.
- (03) Attempt to have all lines (rigging, etc.) removed from the water to avoid fouling the propellers.
- (04) Maintain communications between the coxswain and crewmembers.
- (05) Have all required equipment tested and ready.
- (06) Approach distressed vessel with fenders rigged and lines at the ready.
- (07) Approach a vessel on fire from the windward side.
- (08) Remove survivors first, then back off, and evaluate the fire.
- (09) If the risk of explosion is not known (cannot determine what cargo is onboard), back off and do not attempt to fight the fire.
- (10) Situations may dictate that survivors enter water to be rescued.
- (11) When necessary, dewater the distressed vessel while keeping all equipment aboard the assisting vessel.
- (12) Always keep the Operational Commander or parent unit informed.

NOTE 

For more information concerning Coast Guard fire fighting policy, see Reference (m).



Section B. Flood Control and Dewatering

Introduction Boats sometimes become damaged in groundings, in collisions, or from striking submerged objects. These mishaps may result in a holed, cracked, or weakened hull. If the hull has been damaged to the extent that water is entering the interior of the boat, it must be plugged or patched to keep the boat afloat.

NOTE 

The primary purpose of SAR is to save lives at sea. Conducting damage (flooding) control operations to save property alone should only be done after a complete risk assessment of the situation has been done to ensure the crew will not be subjected to undue risk. If available, salvage services should be considered before conducting this type of operation.

In this Section This section contains the following information:

Title	See Page
Plugging Holes	5-4
Patching Holes	5-5
Patching Cracks	5-8
Dewatering	5-8

Plugging Holes

B.1. Plugs The simplest method of stopping a small hole in wooden or metal hulls is to insert a plug or plugs. Plugs are usually made of a soft wood such as pine or fir. Plugs are used individually if they fit the hole, or in combination with other materials to make a better fit.

B.2. Preparing Plug Wrapping cloth around each plug before inserting them in the hole will help to keep the plug in place. It also fills the gaps between plugs.



B.3. Inserting Plugs

When plugging holes, it is usually easiest to insert the plugs from the inside. However, sometimes the rough edges protruding inward may make this method impossible. If it is necessary to insert the plugs from the outside, and safe to do so, the inboard end(s) of the plug(s) should be fitted with screw eyes. A line should be attached to each screw eye and fastened to a structure inside the boat. It will hold the plug in place (Figure 5-1).

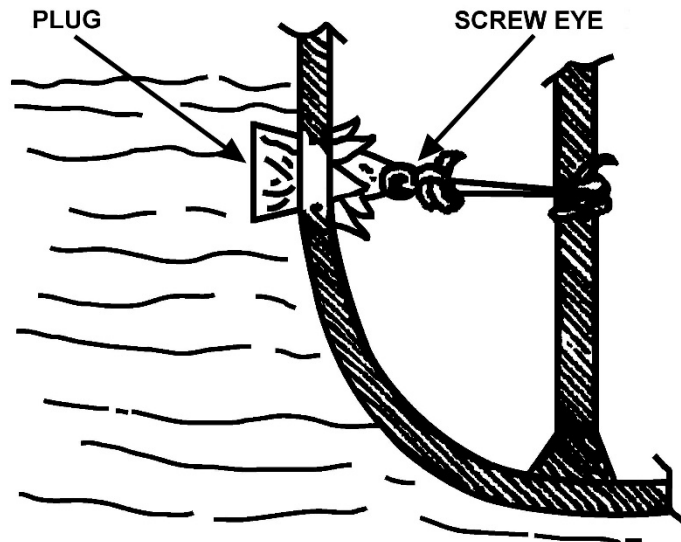

Figure 5-1
Screw Eye

B.4. Large Holes

Large holes are generally too difficult to plug. A patch can be used to reduce the flow of water through a large hole, if an attempt is made.

B.5. Fiberglass Hulls

Fiberglass may be the most difficult hull material to plug. Wooden conical plugs driven into the hole may do nothing more than cause further splitting and cracking and add to an already difficult situation. The best method of plugging a hole in fiberglass is to shove some pliable type of material into it such as a rag, shirt, or piece of canvas. A PFD or a blanket may also work well.

Patching Holes

B.6. Holes Below the Waterline

Patching holes below the waterline is usually a difficult task because of the pressure exerted by the water and the inaccessibility to the holed area. Small holes should be patched from the inside. Some type of material should be placed over the hole and hold it in place with another object. For example, if the boat were holed in the bottom, a PFD or seat cushion could be placed over the hole and held in place with a gas can, cooler, or toolbox.



B.7. Large Holes Below the Waterline

Large holes below the waterline are extremely difficult to patch. The pressure of the water flowing through the hole will not usually allow a patch to be installed from the inside.

B.7.a. Collision Mat

If a collision mat (a large piece of canvas or vinyl) is available, it can be used to patch a large hole (**Figure 5-2**). Perform the following the procedures while placing the mat over the hole:

Step	Procedure
1	Tie four lines to the corners of the mat (patch).
2	Position the mat by lowering it over the bow.
3	Have someone walk down each side of the boat, two of the lines for each person.
4	Slide the mat along the bottom of the boat.
5	Once the mat covers the hole, secure the four lines topside. The pressure of the water against the patch will also help to hold it in place.

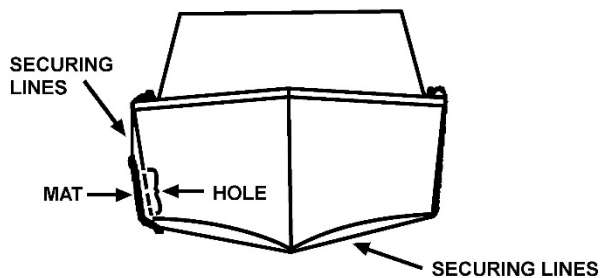
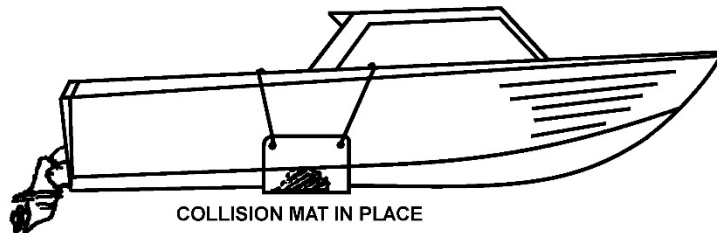

Figure 5-2
Collision Mat



B.8. Holes above the Waterline

Holes above the waterline may be more dangerous than they appear. As the boat rolls, they admit water into the boat above the center of gravity. This water reduces the stability of the boat. Plugs or patches (Figure 5-3) on the inside or outside the hull should be used to cover these types of holes. The following procedures are an effective method for patching holes above the waterline:

Step	Procedure
1	Use a pillow, spare PFD or cushion that has a small hole punched in the center.
2	Place the cushion over the holed area from the outside and back it with a board of the same approximate size. The board should also have a small hole through the center.
3	Pass a line through the board and cushion and knot the end of the line outside the board.
4	Secure the entire patch by attaching the other end of the line to something firm inside the boat.

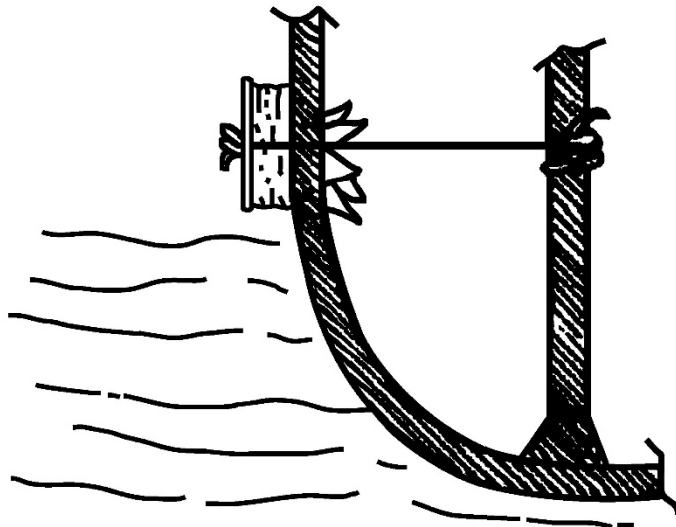

Figure 5-3
Patching Hole Above Waterline



Patching Cracks

B.9. Cracks in Hulls

To patch a crack in the hull, use the following procedures:

Step	Procedure
1	Stuff the crack with something pliable such as a rag or line.
2	Place a piece of canvas or rubber over the crack to serve as a gasket.
3	Back the patch with a solid object such as a piece of plywood, panel door, or similar material.
4	Use nails, screws, or wedges to hold the patch in place.
5	To prevent the crack from traveling, especially in fiberglass, drill holes at each end of the crack. These holes will relieve the pressure at the ends of the crack, permitting the hull to flex without extending the crack.

Dewatering

B.10. Introduction

Dewatering a vessel is normally secondary to putting out the fire, but it remains an important follow-on consideration. Indeed, it may be possible to use dewatering equipment to keep the boat from capsizing. Know what equipment is available for dewatering and how to use it.

B.11. Action Before Dewatering

Action taken before beginning to dewater a disabled vessel varies depending upon the nature of flooding. Regardless, a coxswain should always brief crewmembers on what procedures to follow while emphasizing safety. If crewmembers have just put out a fire on a boat, someone must then board the vessel and check for flooding, but only when safety permits. A coxswain will direct crewmembers how to safely accomplish this inspection for flooding.

B.11.a. Initial Actions on Scene

When responding to a distress call of a disabled vessel taking on water, the initial action on the scene will be as follows:

Step	Procedure
1	Search the immediate area for people in the water.
2	After all survivors are recovered and all persons onboard the sinking craft are accounted for and have been evacuated to a safe place, check the sinking craft for hull damage or other sources of flooding.



3	Before entering any flooded compartment/vessel, every attempt to secure electrical power should be made to reduce the chance of electrical shock.
4	Once a source of flooding is determined, crewmembers may perform procedures to reduce water flow into the boat. Safety of the crew is the first priority. The distressed vessel should not be boarded if it seems unstable and could possibly capsize or sink.
5	Once onboard, the crewmembers shall wear PFDs and not go below decks if there is any threat of capsizing or sinking.
6	When flooding has been controlled, or at least reduced to a minimum, dewatering can begin. How a vessel is dewatered depends on the conditions that exist at the scene.

NOTE *~*

This handbook does not cover technical information and use of commercial gasoline powered pumps, high capacity, manual, or electrical bailing pumps. See and follow the manufacturing instructions for usage while dewatering.

**B.12.
 Dewatering with
 an Eductor**

Dewatering with an eductor can be performed only when weather conditions permit your boat to safely come alongside a disabled vessel and remain close to it.

An eductor is used in conjunction with the fire pump on the boat. A 1½-inch fire hose attached to one of the 1½-inch outlets of the fire main is connected to the pressure supply inlet of the eductor. A 2½-inch fire hose is connected to the discharge outlet. The eductor itself is submerged, either vertically or horizontally, in the flooded area to be dewatered. Suction is obtained in either position because of uneven edges of the suction end of an eductor. All eductors operate in fundamentally the same manner. Water from a boat’s fire pump is forced through a fire main and out through the discharge hose. As pressure of this rapidly moving water passes over the suction opening, it creates a vacuum. The vacuum, or suction, pulls water up through a suction hose, out through the discharge hose, and over the side of the boat. A discharge hose must always lead over the side and a suction hose must always be placed in flooded areas of a disabled boat. If they are inadvertently reversed, a disabled vessel will quickly be filled with water pumped aboard through the discharge line instead of dewatering it with a suction line (**Figure 5-4**).

CAUTION !

Make certain there are no kinks or obstructions in a discharge line. Their presence will cause an eductor to pump water into a flooded boat through the suction line.

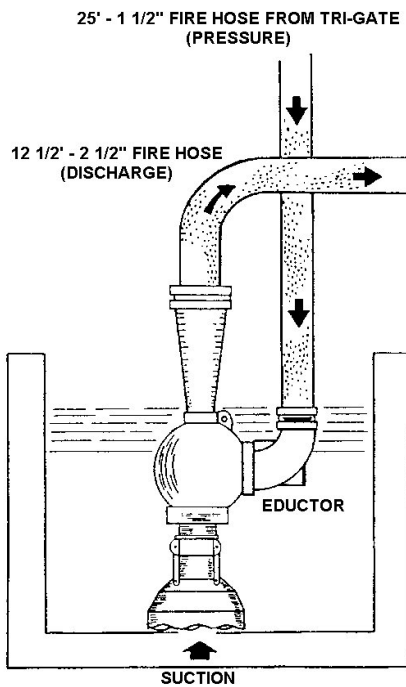

Figure 5-4
Eductor Rigged for Dewatering

**B.13.
Dewatering
Using a Drop
Pump**

Many first responder boats carry a portable, gasoline-powered drop pump (Figure 5-5). Dewatering with a drop pump is done with the pump placed on the disabled boat. Depending on the model of drop pump, approximately 100-250 gallons of water per minute (GPM) can be removed from a flooded compartment.

WARNING

Since the drop pump is water cooled, it should not be used to dewater a boat with fuel contamination in its bilges.



FLOATABLE CONTAINER

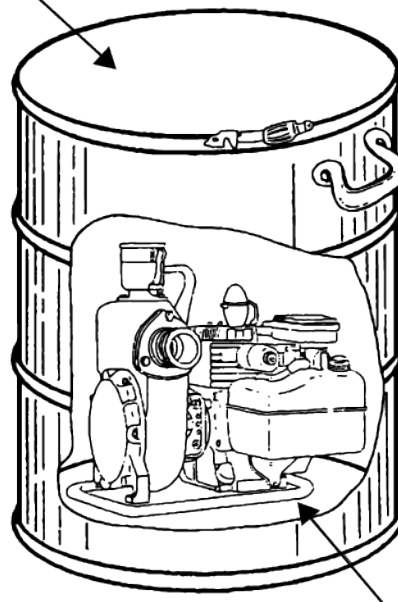

Portable dewatering pump

Figure 5-5
Drop Pump

B.13.a. Pump
Operation

Since the agencies switch out models of drop pumps when newer models become available, every drop pump comes with instructions specifically designed for that model pump. These instructions for operation can be found inside the storage container. These are extremely helpful if the pump is transferred to another vessel to use.

All crewmembers should be familiar with these instructions and practice operating the drop pump often.

The following procedures are the basic steps for setting up and using a drop pump (Figure 5-6). Again, refer to the instructions that come with the pump for specific operation instructions.

CAUTION !

Breathing exhaust fumes can be dangerous. Do not attempt to start or operate a pump while it is in a container. Once a pump is started, ensure sufficient ventilation is present to allow exhaust gases to dissipate into the atmosphere. Do not operate a drop pump below deck.



Step	Procedure
1	Pull the handle to release the tension ring or undo the locking clips on the storage container.
2	Lift the lid and open the plastic bag. Lift out the drop pump, hoses, and fuel.
3	Check the engine oil level (oil must be visible).
4	Check the fuel tank (fill if needed) and then connect fuel line to the fuel tank.
5	If applicable, open fuel vent cap by turning counterclockwise.
6	Connect the discharge hose and lay it out on deck so there are no kinks or twists. During operation, the discharge hose should be manned or tied off to prevent flooding into another space.
7	Attach connection end of suction hose to pump and lower strainer end into compartment to be dewatered.
8	Turn the engine IGNITION switch to the “ON” position.
9	Open the fuel valve on the engine by pushing it to right into the “ON” position.
10	Move the choke level to the “CLOSED” position.
11	Set throttle to about 1/3 open.
12	Prime the pump by rapidly cycling the hand primer handle in and out until water is discharged from the primer cylinder cap.
13	Start the pump by pulling the recoil starter rope.
14	Move the choke lever to the “OPEN” position once the engine starts.
15	Check for water from the discharge hose.
16	Rapidly cycle the hand primer handle until water is flowing from the discharge hose.
17	Move throttle through its full range accordingly, checking for maximum flow output.
18	Post a watch on the pump. The engine will run approximately 4-5 hours on one tank of fuel. The pump watch must be alert for debris around the strainer and must ensure the strainer remains submerged. Watch for fuel leaks.

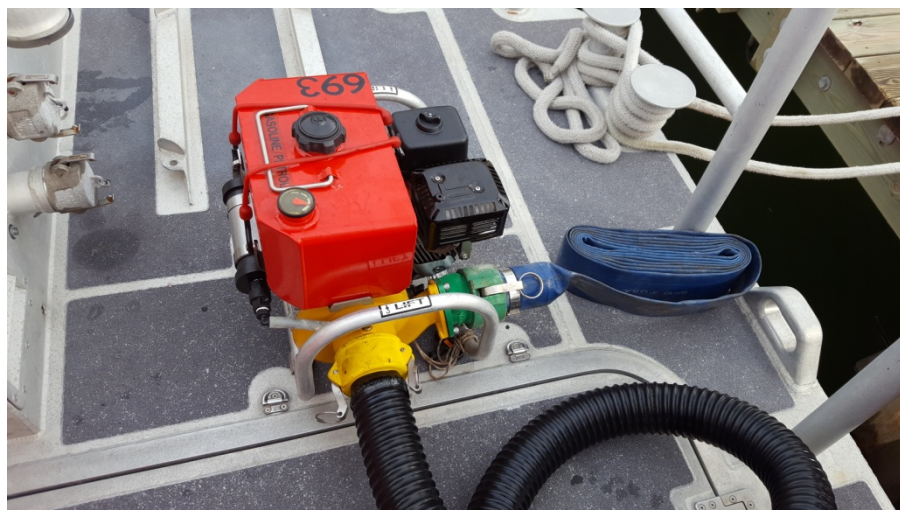

Figure 5-6
Drop Pump Readied for Dewatering Action

B.13.b. Passing a Drop Pump

When secured in its watertight container, a drop pump can be easily passed from one boat to another. There are two methods for passing a pump.

B.13.b.1. Directly Passing a Drop Pump

The easiest method for transferring a drop pump is to pull alongside the flooding vessel and simply transfer the pump to the other vessel. At least two people are always required to move a pump because it is heavy and awkward to carry.

If coming alongside is not a safe option, use the following procedures to directly pass a drop pump:

Step	Procedure
1	Determine the rate of drift.
2	Secure a 2-inch mooring line to a bridle attached to a pump container or pump container handles (Figure 5-7).
3	Secure a heaving line to the mooring line.
4	Rig a tending line from the pump to the boat to enable controlling the pump's movement once it is in the water and hauling it back in the event of an emergency (Figure 5-8).
5	Cast the heaving line, and direct people aboard the disabled boat to haul it in.
6	Lower the drop pump overboard and direct people aboard the disabled boat to haul in on the line. Pay out the tending end of the line as it is being hauled in.



Figure 5-7
Securing Lines to Drop Pump Container

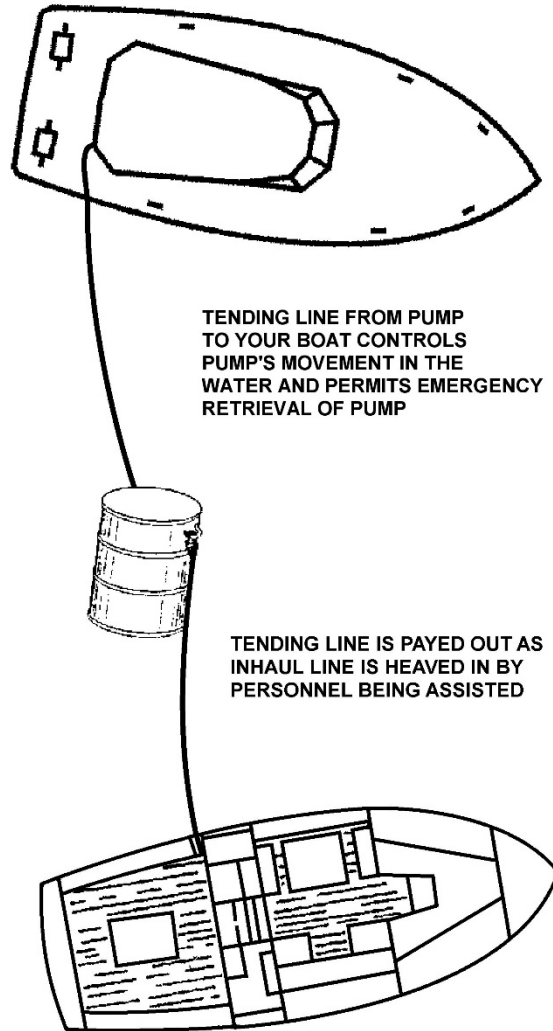

Figure 5-8
Directly Passing a Drop Pump Using Tending Lines



B.13.b.2.
Passing a Drop
Pump into a
Boat in Tow

If it becomes necessary to dewater a vessel during a tow, it is easier to transfer the drop pump before placing the vessel in tow. If for some reason the disabled vessel starts taking on water during the tow, use the following procedures to pass the drop pump to the boat in tow astern:

Step	Procedure
1	Rig a bridle to both handles of a pump storage bracket if a permanent bridle has not already been attached.
2	Estimate the distance from the bow of the vessel back to the lowest point along the side of its hull. Make up a length of mooring line approximately equal to this distance. Secure the mooring line to the bridle rigged in step 1 with a shackle.
3	Make a bowline in the other end of the mooring line around the towline. A shackle may be substituted for a bowline. Regardless of the device used, bow line or shackle, the opening must be large enough for the mooring line to run freely down the tow line (Figure 5-9).
4	Lower the pump over the leeward side and allow it to float back to the boat in tow (Figure 5-10).
5	Maintain only enough headway for steerage to keep the pump from submerging.
6	Instruct the vessel in tow to turn their rudder so as to head into the wind or current. This allows the pump to drift away from the towed vessel's bow and down its side unobstructed.

NOTE 

Risk assessment is important should the towed vessel start to take on water. Always consider removing personnel from the vessel.

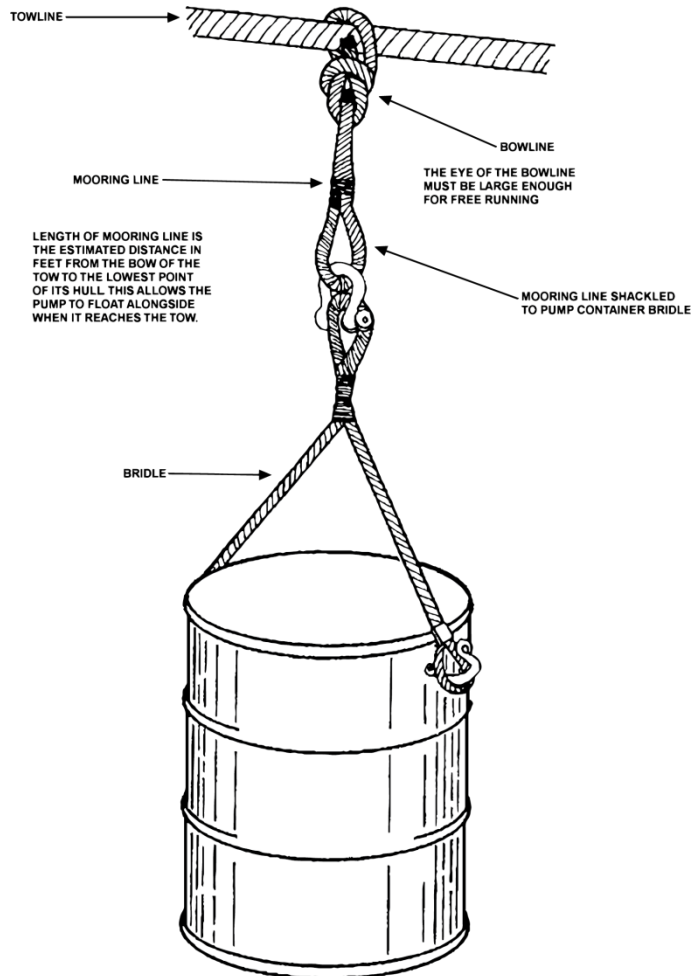

Figure 5-9
Drop Pump on the Towline

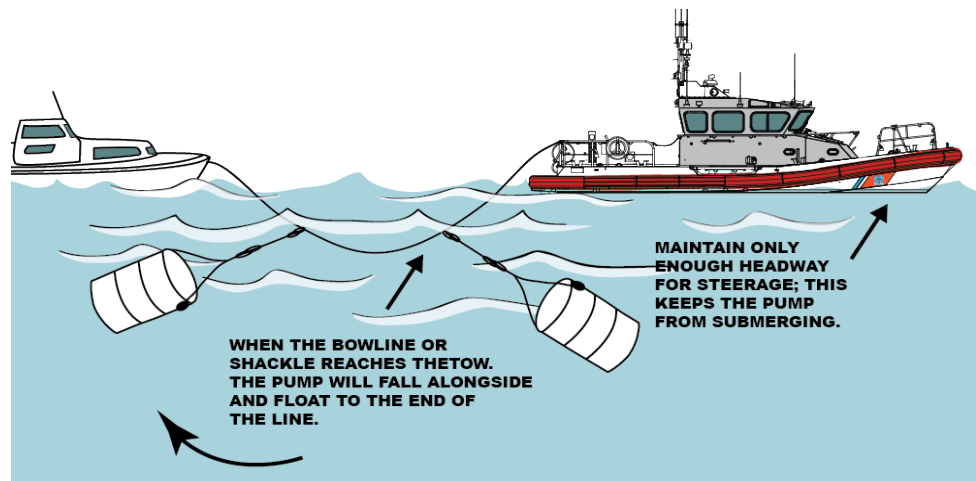

Figure 5-10
Passing a Drop Pump on the Towline



B.13.c.
Securing a
Pump

There are separate procedures for securing a drop pump depending on whether it is being secured because of an emergency or to be stowed.

B.13.c.1.
Securing in an
Emergency

Perform the following procedures for securing:

Step	Procedure
1	Turn the engine IGNITION switch counterclockwise to the “OFF” position. If engine fails to secure, disconnect quick fuel fitting from the fuel tank.

B.13.c.2.
Securing for
Storage

Perform the following the procedures when securing the pump for storage:

Step	Procedure
1	Disconnect the fuel line from fuel tank.
2	If applicable, turn fuel tank cap clockwise to close vent valve.
3	Continue to pump water until the engine stops from lack of fuel.
4	Close fuel valve by pushing it to the “OFF” position.
5	Turn the engine IGNITION switch counter clockwise to the “OFF” position.
6	Disconnect the suction/discharge hoses from the pump. Allow hoses to drain completely.
7	Drain water from the impeller case by tipping the pump towards the discharge outlet.
8	Cycle the hand primer pump to discharge residual water.
9	Check engine oil and fuel tank levels. Refill as required.
10	Allow the engine, pump, hoses, and associated kit components to completely dry.
11	After drying, re-stow all gear in accordance with maintenance procedure card.



Section C. Fire Fighting

Introduction The possibility of fire can never be completely eliminated and is always a threat.

Boat crewmembers must be especially alert for fire, its possible causes, and areas on a boat that are very susceptible to fire. There are some causes of fire that are more frequently encountered on boats. Crewmembers should learn to be especially watchful for them.

In this Section This section contains the following information:

Title	See Page
Policy	5-19
Preventive Actions	5-20
Susceptible Areas	5-20

Policy

C.1. Coast Guard Fire Fighting Activities Policy

Among the provisions of the Ports and Waterways Safety Act of 1972 (PWSA) (33 USC 1221 *et seq.*) is an acknowledgment that increased supervision of port operations is necessary to prevent damage to structures in, on, or adjacent to the navigable waters of the United States, and to reduce the possibility of vessel or cargo loss, damage to life, property, and the marine environment. This statute, along with the traditional functions and powers of the Coast Guard to render aid and save property (14 USC 88(b)), is the basis for Coast Guard fire fighting activities.

The Coast Guard has traditionally provided fire fighting equipment and training to protect the lives of Coast Guard personnel, its vessels, and property. Coast Guard and Auxiliary units are also called upon to assist in fighting major fires onboard other vessels and at waterfront facilities. Although the Coast Guard will help fight fires involving vessels or waterfront facilities, it is not a primary response capability. Local authorities are responsible for maintaining adequate fire fighting capabilities in U.S. ports and harbors. The Coast Guard renders assistance as time and resources are available, based on the level of personnel training and adequacy of equipment available for a specific situation at hand.



Preventive Actions

C.2. Description To avoid fire, the single most important consideration is prevention. During boat and equipment checks, all systems must be inspected including the fuel, oil system, and wiring. Crewmembers should check for abrasions, cracked wiring, loose connections, or pinholes in oil and fuel lines. Any discrepancy must be corrected at the time it is discovered.

C.3. Measures of Practice The following are also good fire prevention measures for you to practice:

- (01) Keep oil and grease out of bilges.
 - (02) Identify and correct any sources of fuel or oil leaks.
 - (03) Clean up any spilled fuel or lube oil immediately and properly dispose of it ashore.
 - (04) Stow cleaning materials off the boat.
 - (05) Keep all areas free of waste material.
 - (06) Use proper containers for flammable liquids.
 - (07) Be alert for suspicious odors and fumes, and vent all spaces thoroughly before starting engine(s).
-

Susceptible Areas

C.4. Spontaneous Ignition This source of fire is often overlooked as a cause of fire aboard a boat. Many common materials are subject to this dangerous chemical reaction. A spontaneous ignition can easily occur aboard a boat when an oil or paint soaked rag is discarded in the corner of a compartment or engine room.

C.4.a. Oxidation When an area is warm and there is no ventilation, oil on a rag begins to oxidize (to react chemically with the oxygen in the warm air around it). Oxidization is a natural process that produces heat. Heat produced by oxidization causes any remaining oil to oxidize even faster and produce still more heat.

C.4.b. Ventilation Since heat is not drawn away by ventilation, it builds up around a rag and causes it to get hot enough to burst into flames, after which it can ignite any nearby flammable substances and start a major fire. All of this occurs without any additional or outside source of heat. In this case, fire prevention is a matter of good housekeeping. Cleaning rags and waste should be stored in closed or sealed metal containers and discarded as soon as possible.



C.5. Engine Room Fires

Engine rooms are particularly vulnerable to electrical, fuel, and oil fires. There are several ways that engine room fires can readily start. Water spraying from ruptured seawater lines can cause severe short-circuiting and arcing in electric motors (alternators), electrical panels, and other exposed electrical equipment. This, in turn, can ignite insulation and nearby combustible materials. Even more serious than leaking seawater lines are ruptured fuel and oil lines near electrical equipment. All crewmembers must constantly monitor these lines for leaks.

C.5.a. Electrical System

The electrical system can short and cause a fire. These fires are typically small and easily controlled with either carbon dioxide (CO₂) or dry chemical (PKP) extinguishers.

C.5.b. Fuel Line

If fittings leak, fuel can drip onto a hot manifold and ignite. This situation could continue unnoticed for some time, allowing a major fire to develop when a manifold finally gets hot enough to ignite all leaked fuel.

C.5.c. Lube Oil Line

This line, if leaking or ruptured, will allow lube oil to spill onto a hot engine. As the burning lube oil collects on and around an engine, the engine's fuel supply line would probably be burned through. This would provide a fire with a continuous fuel supply, even after engines have been shut down. Fuel continuing to spill into the bilges, fires can spread and block access to the engine compartment, eventually leading to the development of a major fire.

C.5.d. Bilge Areas

Fire occurs in bilge areas because of fuel or oil accumulation. Most often, oil or gas leaks into bilges from an undetected break in a fuel or lube oil line. The oil vaporizes, and flammable vapors build up in and around bilge areas. Once these vapors are mixed with air in the right proportions, a spark can ignite them and cause a fire or explosion. Bilge fires can move very quickly around machinery and piping and are not easily controlled. They are more difficult to extinguish than most other types of engine room fires. Bilge areas should be watched closely. Oil in a bilge nearly always indicates a leak, and all fuel and lube oil lines should be checked until the leak is found.

CAUTION !

An explosion is a common accident for boats when bilges are not properly ventilated before starting engines. A spark from "turning the key" can instantly ignite the trapped gas creating a potentially deadly explosion.



C.6. Electrical Circuits and Equipment

With properly insulated and wired equipment, electricity is a safe and convenient source of power. However, when electrical equipment exceeds its useful life, is misused, or is improperly wired, it can convert electrical energy to heat. Equipment then becomes a source of ignition and a “fire hazard.” For this reason, electrical equipment must be installed, maintained, tested, and repaired in strict accordance with published regulations.

NOTE

All work on electrical equipment must be completed by qualified personnel.

C.6.a. Replacement Parts and Equipment

Standard residential or industrial electrical equipment does not last very long at sea. The salt air causes “corrosion,” the boat’s vibration breaks down the equipment, and a steel hull can cause erratic operation or a shorted circuit. As a result, equipment or its wiring may overheat or arc, causing a fire when flammable materials are located nearby. For this reason, only approved replacement parts and equipment should be installed aboard boats. Given proper maintenance, these parts and equipment are designed to withstand the strenuous conditions encountered at sea.

C.6.b. Wiring and Fuses

Insulation on electrical wiring will not last forever. With age and use, it can become brittle and crack. It may be rubbed (chafed) through or broken by abuse or by the vibration of a boat. Once insulation is broken, bare wires may be exposed and are dangerous. A single exposed wire can arc to any metal object. If multiple wires are exposed, they can touch each other and cause a short circuit. Either condition could produce enough heat to ignite insulation on wiring or some other flammable material nearby. Replacing wires that have faulty or worn insulation can prevent this type of fire. Install only fuses and circuit breakers of the proper size for their circuits.

WARNING

When a fuse or circuit breaker in a particular circuit is too large, a circuit will not “break” when overloaded. Instead, increased current will continue, a circuit will overheat, and eventually insulation will burn and may ignite other combustible material in the vicinity.

C.6.c. Temporary and Unauthorized Repairs and Patches

“Rigging” of electrical panels to serve additional equipment is a dangerous practice. Wiring in every electrical circuit is designed to carry a specified maximum load. When circuit wiring is overloaded with too many pieces of operating equipment, in addition to possibly damaging the equipment, it can overheat and burn its insulation. Hot wiring can also ignite flammable materials in surrounding areas.

C.6.d. Electric Motors (Alternators)

Faulty electric motors are major causes of fire. Problems may result when a motor is not properly maintained or when it exceeds its useful life. A motor requires regular inspection, testing, lubrication, and cleaning. Sparks and arcing can result if a winding becomes short-circuited or grounded or if the brushes do not operate smoothly. If a spark or an arc is strong enough, it can ignite nearby combustible material. Lack of lubrication may cause the motor bearings to overheat, with the same result.



C.6.e. Charging
Batteries

When batteries are charging, they emit hydrogen, a highly flammable gas that is potentially explosive. Hydrogen is lighter than air and will rise as it is produced. If sufficient ventilation is not available at the highest point above where a battery is being charged, hydrogen will collect at the overhead. Then, any source of ignition will cause an explosion and fire.

CAUTION !

Battery gases are highly explosive. Never smoke around a battery and never disconnect, change out, or perform maintenance on a battery until the surrounding space has been thoroughly ventilated.



Section D. Fire Theory, Classifications, and Fuel Sources

Introduction As a boat crewmember, it is important to understand the theory of fire, the different classifications of fire, and the types of fuels that perpetuate fires. This knowledge will enable boat crewmembers to identify the type of precautions, equipment, and extinguishing agents required to successfully fight fires.

In this Section This section contains the following information:

Title	See Page
Fire Theory	5-24
Classification of Fires and Fuel Sources	5-25

D.1. Fire Theory Fire is a chemical reaction known as combustion. It is defined as a state, process, or instance of combustion in which fuel or other material is ignited and combined with oxygen, giving off light, heat, and flame.

D.1.a. Fire Tetrahedron Theory A theory has been developed to explain fire combustion and extinguishment. This theory can be represented by a 4-sided geometric figure, a tetrahedron (**Figure 5-11**). The base of this figure represents a chemical reaction. The 3 standing sides of the figure represent heat, oxygen, and fuel. Removing one or more of the 4 sides will make a tetrahedron incomplete and cause a fire to be extinguished.

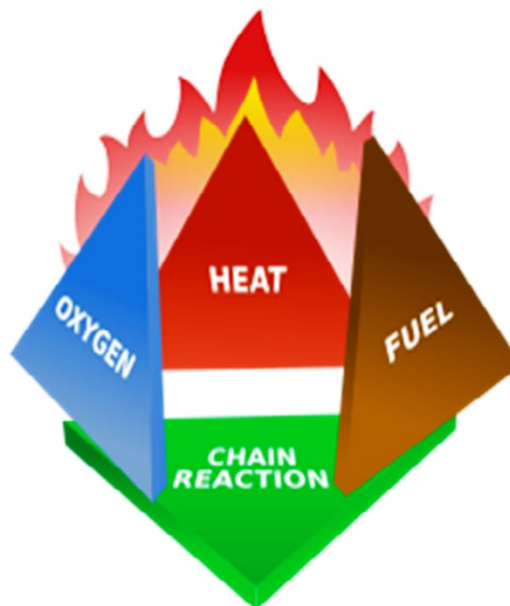

Figure 5-11
Fire Tetrahedron



D.2. Classification of Fires and Fuel Sources

The following are the four classes of fires:

- (01) Class A,
- (02) Class B,
- (03) Class C,
- (04) Class D.

D.2.a. Class A

A Class A fire involves common combustible materials. Fuel sources within this class include wood and wood-based materials, cloth, paper, rubber, and certain plastics.

D.2.b. Class B

A Class B fire involves flammable or combustible liquids, flammable gases, greases, and similar products. Fuel sources within this class include petroleum products.

D.2.c. Class C

A Class C fire involves energized electrical equipment, conductors, or appliances.

D.2.d. Class D

A Class D fire involves combustible metals. Fuel sources within this class include sodium, potassium, magnesium, and titanium.



Section E. Fire Fighting Equipment

Introduction Specialized equipment is used to apply extinguishing agents. In this Section, the basics of how to operate the most common kinds of fire fighting equipment found on Coast Guard boats will be discussed.

In this Section This section contains the following information:

Title	See Page
Fire Hose	5-26
Spanner Wrench	5-27
Vari-Nozzle	5-28
CG-P6 Portable Dewatering Pump with Attached Fire Fighting Hose and Nozzle	5-29

Fire Hose

E.1. Description A fire hose is a basic fire fighting tool. Although taken for granted, hoses are highly developed tools that must be properly used and maintained.

A standard fire hose is a double-jacketed, cotton or nylon-impregnated, rubber-lined, orange hose. It comes in 2 common diameters, 1½-inch or 2½-inch, and is produced in standard lengths of 50 feet. In some cases, a fire hose on smaller boats must be shorter than the standard length because of limited space. In many cases the fire hoses available on boats are a bit different than the standard double-jacketed, cotton or nylon-impregnated, rubber-lined, hose you see fire fighters using. It is a double jacketed, soft, nitrile rubber covered hose. The fire hose is used in conjunction with a dewatering pump and provides limited fire fighting capability.

CAUTION !

A charged hose has considerable force. Ensure it is properly manned at all times to prevent it from swinging out of control.

E.2. Safety Precautions

Before using a fire hose, several safety checks must be performed. These checks may seem needlessly time-consuming at a fire scene. Nonetheless, they must be performed to prevent a malfunction in a hose system that could cause even more time to be lost. The following checks should be performed:

- (01) Make certain all hose connections are tight and a hose is free of kinks and twists.
 - (02) Ensure the bail on a nozzle is closed before a hose is charged.
 - (03) Never lay a hose on an excessively hot deck.
 - (04) Be sure there are enough people available to control a fire hose before charging it. Never leave a charged hose unattended.
-



E.3. Minimum Operators

A minimum of two people is recommended to control a 1½-inch hose.

E.4. Coupling

A fire hose has brass or metal fittings, known as male and female couplings at its ends. This allows one hose to be attached to another or to a fitting. A female coupling connects to a boat's fire main or portable pump. A male coupling connects to a nozzle or to a female coupling on another length of hose. To connect lengths of fire hose, crewmembers take half a turn to the left on the female coupling to set the threads and then turn to the right until the connection is tight. Fittings should be hand tight.



Figure 5-12
Fire Fighting Hose with male and female couplings

Spanner Wrench

E.5. Description

Spanner wrenches are very important when working with fire hoses. As mentioned before, when connecting fire hoses to fittings or another hose, connections should be hand tight, allowing for an easy disconnect. Sometimes tightening connections only hand tight is not enough. This is where a spanner wrench helps out. Spanner wrenches are also useful if a fire hose is unable to be disconnected from a connection because it has been put on too tight.

A spanner wrench is adjustable so that it can be used with all standard sizes of fire hoses. A range of adjustment is indicated on the handle of a wrench. A curved tip on the working end of a wrench is made to fit all notches in a coupling.

E.6. Safety Precautions

Spanner wrench safety precautions are as follows:

- (01) As with using any wrench, be careful not to get fingers or other objects caught between the wrench and the coupling.
 - (02) Ensure the working end of the wrench is in the notch before applying heavy pressure.
-



E.7. Operation

On properly maintained hoses, connections may be effectively tightened by hand. However, if there is water leakage at a connection, a spanner wrench (**Figure 5-13**) may be used. Once a wrench is adjusted, the tip of a wrench is inserted into the notch and the wrench handle pulled to the right.



Figure 5-13
Spanner Wrench

Vari-Nozzle

E.8. Description

The vari-nozzle can be used for fighting all classes of fires. In the fog position, it can also be used for personnel protection by creating a shield of water spray. A Navy vari-nozzle is fitted with a pistol grip handle on the underside of the nozzle and a two-position bail handle on the top that operates the nozzle. The vari-nozzle's spray pattern is adjusted by rotating the variable pattern tip and can range from a 90° wide-angle spray to a narrow straight stream as well as intermediate patterns between these extremes.



E.9. Operation This nozzle (**Figure 5-14**) is used with AFFF for extinguishing Class B fires.

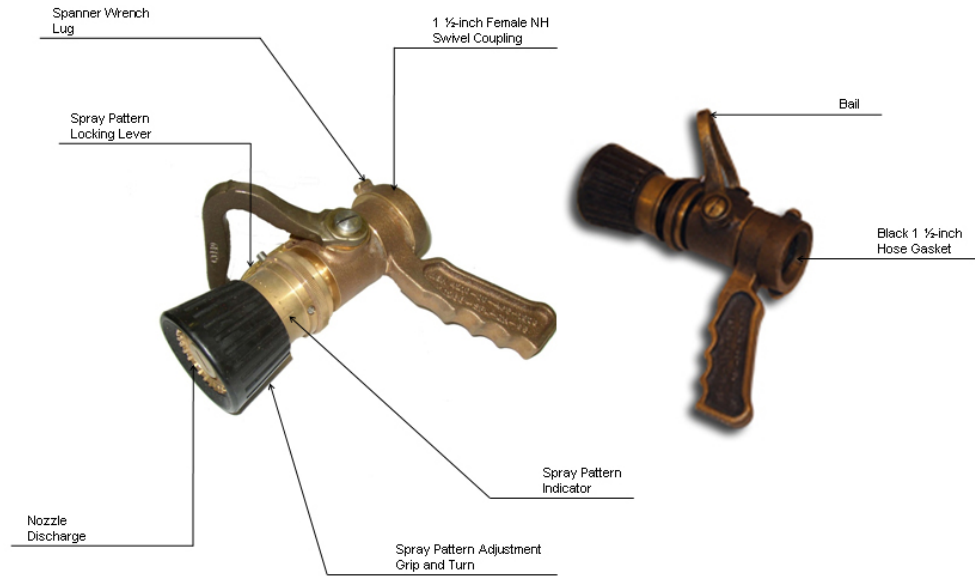

Figure 5-14
Vari-Nozzle

CG-P6 Portable Dewatering Pump with Attached Fire Fighting Hose and Nozzle

E.10. Description

The CG-P6 portable dewatering pump with attached fire fighting hose and nozzle is used to suppress fire aboard vessels. Coast Guard personnel shall not engage in independent fire fighting operations, except to save a life or in the early stages of a fire to avert a significant threat without undue risk.

E.11. Minimum Operators

The CG-P6 portable dewatering pump with fire fighting hose and nozzle is operated by a minimum of two boat crew members; one to operate/monitor CG-P6 and one to control and direct the hose and nozzle.

WARNING

Coast Guard personnel shall not engage in independent fire fighting operations except to save life, or in the early stages of a fire to prevent a significant threat without undue risk. *See Reference (m) for additional policy guidance.*

E.12. CG-P6 Dewatering Pump

The CG-P6 portable dewatering pump consists of a 6 ½ horsepower, 4-cycle gasoline driven engine with a rated output of 250 gallons of water per minute at a 12-foot suction lift. Under load this pump will operate for approximately 4 to 5 hours on a full tank of gasoline. Refer to Chapter 5, Section B.13 for procedures on operating the CG-P6 Portable Dewatering Pump.



E.13. Fire Fighting Hose

A 50-foot fire fighting hose (**Figure 5-15**) with a 1 ½-inch male coupling (attached to nozzle) and 1 ½-inch female coupling (attached to black outlet adapter) that is connected to the CG-P6.



Figure 5-15
Fire Fighting Hose

E.14. Fire Fighting Nozzle

A 1 ½-inch fire fighting nozzle (**Figure 5-16**) is attached to one end of the 50-foot fire fighting hose. The nozzle has a rated output of 75 gallons per minute (GPM).

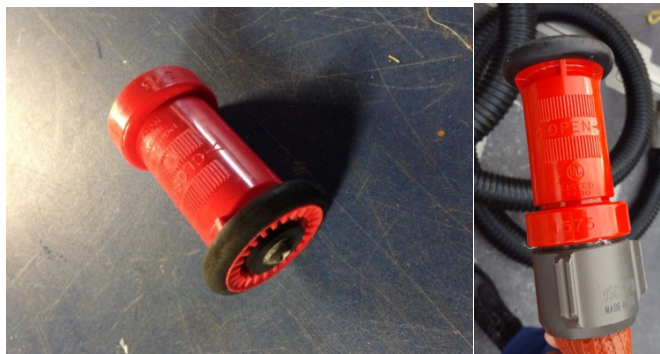

Figure 5-16
Fire Fighting Nozzle



**E.15. Quick
Connection
Coupling
(Applicable
Assets)**

A 6-foot by 3-inch suction hose (**Figure 5-17**) for connecting the CG-P6 to an installed standpipe is available on certain boat types (e.g., MLB, RB-M).



**Figure 5-17
Suction Hose**

**E.16. CG-P6
Discharge Outlet
Adapter**

A 3-inch color-coded coupling (**Figure 5-18**) attached to the discharge outlet of the CG-P6 to allow the attachment of the 50-foot fire fighting hose.



**Figure 5-18
Color-Coded Coupling**



E.17. Fire Fighting Hose and Nozzle Operation

All crewmembers should become familiar with these instructions and practice operating the CG-P6 with fire fighting hose and nozzle attached.

The following procedures outline the basic steps for setting up and operating the CG-P6 pump with fire fighting hose and nozzle attachments (**Figure 5-19**).

NOTE

Refer to the manufacturer instructions for specific information on pump operation and maintenance.

WARNING

Breathing exhaust fumes can be dangerous. Do not attempt to start or operate a pump while it is in a container. Once a pump is started, ensure sufficient ventilation is present to allow exhaust gases to dissipate into the atmosphere. Do not operate a drop pump below deck.

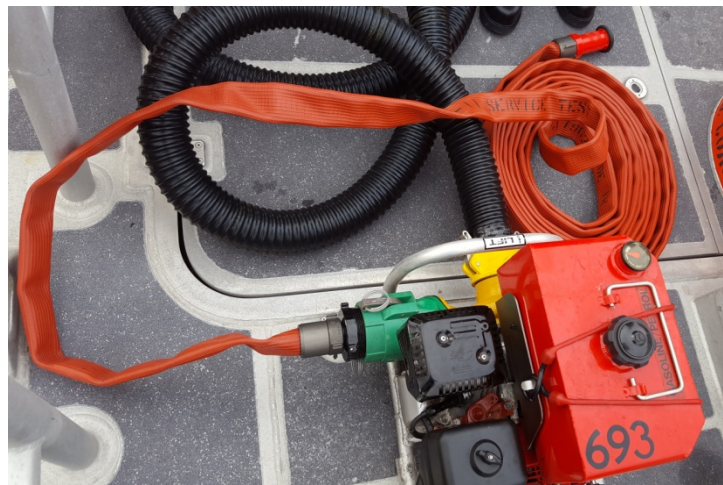



Figure 5-19
CG-P6 Pump With Fire fighting Hose and Nozzle Attachments



Step	Procedure
1	Pull the handle to release the tension ring or undo the locking clips on the storage container.
2	Lift the lid and open the plastic bag. Lift out the drop pump, hoses, and fuel.
3	Check the engine oil level (oil must be visible).
4	Check the fuel tank (fill if needed) and then connect fuel line to the fuel tank.
5	If applicable, open fuel vent cap by turning counter clockwise.
6	Fake out fire hose on deck so there are no kinks or twists. Connect fire hose. During operation, the fire fighting hose should be manned at all times.
7	Attach connection end of suction hose to “Yellow” attachment point of CG-P6 and lower strainer end into the water or connect fire fighting standpipe suction hose on applicable platforms.
8	Turn the engine IGNITION switch to the “ON” position.
9	Open the fuel valve on the engine by pushing it to right into the “ON” position.
10	Move the choke lever to the “CLOSED” position.
11	Set throttle to approximately 1/3 open.
12	Prime the pump by rapidly cycling the primer handle in and out until water is discharged from the primer cylinder cap.
NOTE 	If unable to obtain suction from standpipe pickup, then switch to standard suction hose included in pump container.
13	Start the pump by pulling the recoil starter rope.
14	Move the choke lever to the “OPEN” position once the engine starts.
15	Rapidly cycle the hand primer handle until the fire hose is charged.
16	Move throttle through its full range accordingly, checking for maximum flow output.
17	Post a watch on the pump. The engine will run approximately 4-5 hours on one tank of fuel. The pump watch must be alert for debris around the strainer and must ensure the strainer remains submerged.



E.18. Securing in an Emergency Perform the following procedures for securing:

Step	Procedure
1	Turn the engine IGNITION switch counterclockwise to the “OFF” position. If engine fails to secure, “disconnect quick fuel fitting” from the fuel tank.

NOTE 

Securing for storage refer to Chapter 5, Section [B.13.c.2. Securing for Storage.](#)



Section F. Description and Application of Extinguishing Agents

Introduction Extinguishing agents are defined as anything that eliminates one or more “sides” of a fire tetrahedron. When any one is removed, fire can no longer exist.

Extinguishing agents can be applied in more than one way. Selecting the most appropriate method for applying extinguishing agents depends on the situation. Below are some general guidelines for applying different agents. Later, the equipment that must be used to apply these extinguishing agents will be addressed.

In this Section This section contains the following information:

Title	See Page
How Extinguishing Agents Work	5-35
Applying Water	5-36
Applying Aqueous Film-Forming Foam (AFFF)	5-39
Applying Chemical Agents	5-40
Applying Chemical Agents	5-40
Fire Suppressions Systems	5-45

How Extinguishing Agents Work

F.1. Description Extinguishing agents put out fires by breaking one or more of the four elements of a fire tetrahedron. They work by cooling, smothering, chain breaking, or by a process called oxygen dilution.

- (01) Cooling reduces the temperature of a fuel source below the fuel’s ignition point.
- (02) Smothering separates a fuel source from its oxygen supply.
- (03) Chain breaking disrupts the chemical process necessary to sustain a fire. The element of a chain that is broken depends upon the class of fire and the type of extinguishing agent used.
- (04) Oxygen dilution is a smothering process that reduces the amount of oxygen available to a level below that required to sustain combustion.

The different fire classes, the fuel source for each class, the type of extinguishing agent for each class, and the primary effect of each agent are described as follows:



Class	Fuel Sources	Primary Extinguishing Agent	Primary Effect
A	Common combustible materials such as wood and wood-based materials, cloth, paper, rubber, and certain plastics.	(01) Water (02) PKP (dry chemical)	Removes the heat element.
B	Flammable or combustible liquids, flammable gases, greases, petroleum products, and similar products.	(03) Foam Aqueous Film Forming Foam (AFFF) (04) CO ₂ (05) PKP (dry chemical)	Removes the oxygen element.
C	Energized electrical equipment, conductors, or appliances.	(06) CO ₂ (Carbon Dioxide) (07) PKP (dry chemical)	Removes the oxygen element, and temporarily removes elements of oxygen and heat.
D	Combustible metals, such as sodium, potassium, magnesium, and titanium.	(08) Water (high velocity fog) (09) Sand (placed underneath the metal)	Removes the heat and oxygen elements.

Applying Water

F.2. Description Onboard some boats, water for fire fighting comes from a portable dewatering/fire pump. Some boats have a built-in fire pump through the fire main and hose system or from portable fire pumps. Water is applied to a fire using one of three ways:

- (01) Straight stream,
- (02) Narrow fog (30°),
- (03) Wide fog (90-110°).

F.3. Straight Stream

A straight stream of water is used when long reach and penetrating power are critical.

F.3.a. Class A Fires

On Class A fires, its primary purpose is to break up burning material and to penetrate the base of a flame. Therefore, a straight stream must be directed at the base of flames in a Class A fire.



F.3.b. Class B Fires A straight stream of water is not effective for extinguishing Class B fires. It can cause a violent fire reaction if a water stream atomizes fuel into the air causing an increased surface area. It could also splash the burning liquids spreading the fire to different areas.

F.3.c. Class C Fires A straight stream of water should not be used on a Class C fire because it is a conductor of electricity. Electric current could travel back through a stream of water and be hazardous to a fire fighting team.

F.3.d. Class D Fires A straight stream can also be used on Class D fires for cooling and to wash burning materials over the side.

F.4. Narrow Fog Use of narrow fog is also an effective method of extinguishing fires.

F.4.a. Class A Fires Narrow fog is more useful than a straight stream on Class A fires. One reason is that narrow fog can cool a much wider surface than a stream and, consequently, it can absorb more heat. Additionally, as fog comes into contact with any surface heated by fire, it becomes steam. Steam provides a secondary smothering effect that further aids in extinguishing the fire.

F.4.b. Class B Fires Because of the cooling qualities of finely divided water particles, narrow fog is a successful extinguishing agent on Class B fires. Narrow fog should be used on flammable liquids only when AFFF is not available.

F.4.c. Class C Fires When water is broken into small particles (nozzle fog patterns), there is little danger of its carrying electric current making narrow or wide fog safe to use on Class C fires. However, the nozzles should be operated at least four feet from a fire source.

F.4.d. Class D Fires Water is the recommended agent for Class D fires when applied in quantity as fog patterns. When water is applied to burning Class D materials, there may be small explosions. The firefighter should apply water from a safe distance or from behind suitable shelter.

Class D materials will continue burning until the material is completely consumed, but cooling streams of water can control the burn. However, efforts should be directed at jettisoning or washing the materials over the side to avoid accumulating fire-fighting water inside the vessel. Water fog can also be used to protect fire fighters from excessive heat.

NOTE 

Nozzles can pose an electrical shock hazard to fire fighters. If a nozzle or solid stream accidentally contacts electrical equipment or circuits, an electrical charge may be conducted back to the nozzle operator and cause injury.



F.5. Wide Fog

Wide fog is applied with a vari-nozzle. Wide fog is a pressurized spray less powerful than narrow fog. Because wide fog covers more area than narrow fog, it may be used most effectively when it is possible to get right up next to the fire.

Wide water fog can also provide a heat shield by forming a screen of water droplets between a firefighter and the fire. When fire fighters are properly clothed and hose lines have vari-nozzles, it is not necessary to use low-velocity water for personal protection.

Fog streams used improperly can injure personnel. The fog screen from narrow fog can obscure a nozzleman’s visibility. This is extremely important to remember when no opening exists in the compartment or passageway other than the opening through which the nozzle is being advanced. In spaces with only one opening, heat and smoke can blow back or burst through or around a fog curtain. When circumstances require entering a compartment or passageway that has only one opening, short bursts of solid stream or fog should be directed toward the overhead to knock down the flames.

Using water as an extinguishing agent adds water and weight to a vessel. This can cause the vessel to become unstable. Normally, the water will be removed (dewatered) after the fire has been extinguished. However, to maintain stability and decrease the threat to the crew, the vessel should be dewatered as soon as possible.

F.6. Effectiveness

Water can be effective on all classes of fire, when properly applied for the situation. However, it is most effective for Class A fires. It is recommended for use in Class D (combustible metals) fires for its cooling effect and ability to wash the material away.

F.7. Adapting Equipment

While the high velocity and low velocity fogs described above are effective, it is important to remember that the limited fire fighting capability on most boats requires some adaptation to ensure a fog is applied. Since a fog stream is essentially a stream of water that has been broken up into smaller droplets, you can use the equipment available to achieve this. It could be as simple as splitting the water flow by hitting a rung on a ladder or by deflecting the stream off a bulkhead or deck.



Applying Aqueous Film-Forming Foam (AFFF)

F.8. Description Foam is a blanket of bubbles that extinguishes a fire mainly by smothering. The bubbles are formed by mixing water, air, and a foam-producing agent called foam concentrate. The mixture of water, air, and foam concentrate becomes foam solution.

When using foam, the entire surface of a flame must be covered, otherwise uncovered areas will continue to burn. One gallon of liquid foam concentrate will produce approximately 133 gallons of foam solution. The contents of one 5-gallon can of liquid foam will last about 1½ minutes and will produce about 660 gallons of foam solution.

Foam may be used against Class C fires in an emergency and as a last resort. AFFF concentrate separates at temperatures below 35 °F. This does not affect its usefulness provided the can is shook to re-mix components before use.

F.9. Effectiveness Foam is effective against Class B fires. Foam solution is lighter than the lightest of flammable liquids. When applied to burning liquids, it floats on the surface and prevents oxygen from reaching the fuel source. In addition, the water content of foam provides a cooling effect on the fire. Once the fire is out, a layer of foam should be maintained over the flammable liquid to ensure the fire stays extinguished.



Applying Chemical Agents

F.10. Description Chemical agents can be very effective fire fighting tools. However, they can be ineffective and sometimes dangerous if they are not used properly. Learning the proper use of each chemical agent, including its advantages and disadvantages, before using it to fight a fire is essential. Two chemical agents are discussed below:

- (01) Carbon dioxide (CO₂).
- (02) Dry Chemical /Potassium bicarbonate (PKP).

F.11. Carbon Dioxide (CO₂)

CO₂ is a colorless gas about 50 percent heavier than air. When released from its container, the gas expands to 450 times its stored volume and smothers a fire by temporarily removing the oxygen. Because it is a non-conductor of electricity, CO₂ is the primary agent for class C fires.

CAUTION !

CO₂ should never be used alone to fight a major fire.

F.11.a. CO₂ Effectiveness

CO₂ is effective on small class A, B, and C fires. It has a very limited cooling capacity and does not permanently remove oxygen from a fuel source. Therefore, CO₂ is only effective in knocking down flames. Unless CO₂ is used continuously until all flames are extinguished, the fire could re-ignite (re-flash). In fact, the likelihood of a re-flash is greater when CO₂ is used against a fire than any other type of agent.

A continuous discharge of CO₂ from a fully charged 10-pound extinguisher will last approximately 40 to 45 seconds. The effective range for the portable CO₂ extinguisher is approximately 5 feet. A distance of more than 5 feet may cause the CO₂ to mix with the air and become ineffective.



F.11.b.
 Discharging CO₂

CO₂ gas is not a conductor of electricity. However, when discharging the CO₂, static electricity may build up in the horn. This could be quite dangerous when extinguishing a fire where explosive gases are present. The cylinder should always be kept grounded to the deck when discharging to prevent static charge buildup. CO₂ is most effective in closed spaces away from the effects of strong winds. The following are the operating procedures (**Figure 5-20**) for the CO₂ extinguisher:

Step	Procedure
1	Remove the locking pin from the valve.
2	Carry the extinguisher in an upright position, approaching the fire as close as safety permits.
3	For the smaller 5-pound size, swing the horn up to a horizontal position.
4	For larger CO ₂ extinguishers, ensure the CO ₂ bottle is in contact with the deck to prevent a static charge from building up within the extinguisher.
5	Grasp the insulated horn handle and squeeze the release lever to start the extinguisher.
6	Direct the flow of CO ₂ toward the base of the flame and attack the flame with a sweeping movement of the nozzle.

WARNING 

CO₂ is extremely cold when discharged. The rapid expansion of the gas creates a “snow” that can “burn” or raise blisters if it comes in contact with bare skin. Keep hands on the insulated horn handle when using the CO₂ extinguisher.

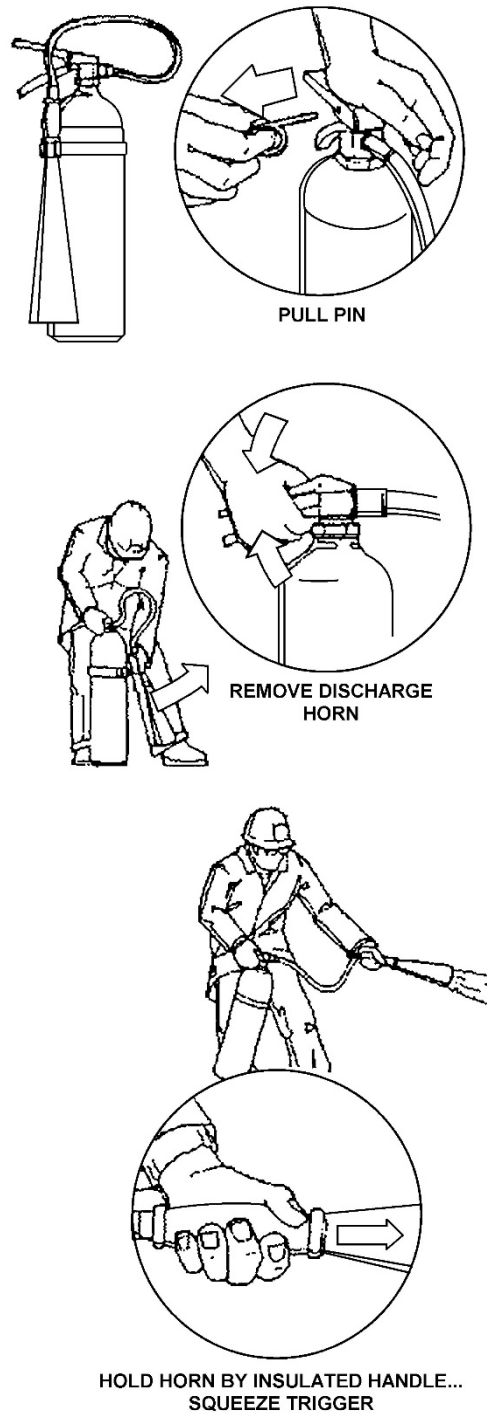

Figure 5-20
Operating the CO₂ Extinguisher



**F.12. Dry
Chemical /
Potassium
Bicarbonate
(PKP)**

PKP is also known as purple K powder. The ingredients used in PKP are non-toxic. When PKP is applied, a dense cloud is formed in the combustion area that limits the amount of heat that can be radiated back to the heart of the fire. Fewer fuel vapors are produced due to the reduced radiant heat. The dry chemical PKP extinguishes flames by breaking the combustion chain.

CAUTION !

Dry Chemical/ PKP, like CO₂, should never be used alone against a major fire for it presents the same hazard of a re-flash as CO₂.

**F.12.a. Dry
Chemical/PKP
Effectiveness**

Dry chemical extinguishers do not have cooling capability. PKP may be effective as a temporary measure for extinguishing a flame, but it dissipates rapidly. Therefore, all hot spots must be cooled to prevent re-ignition. It is effective to some degree on all types of fires, but is particularly effective when used against burning liquids. By first extinguishing a burning liquid with PKP and then laying down a blanket of AFFF to prevent re-flash, dealing with a Class B fire is very effective. Most dry chemical/PKP extinguishers have an effective range of 10-12 feet and will last between 8-20 seconds in continuous use.



F.12.b.
Discharging Dry
Chemicals

The dry chemical or powder contained in these portable containers is expelled by either a gas cartridge or by stored pressure within the container. The following are the procedures (**Figure 5-21**) for using this type of extinguisher:

Step	Procedure
1	Operate the dry chemical extinguisher by following the instructions printed on the extinguisher.
2	Control the discharge of the dry chemical by the nozzle shutoff valve for both cartridge-operated and pressurized dry chemical extinguishers.
3	Approach the fire as close as safety will allow.
4	Remove pin.
5	Squeeze trigger.
6	Direct the discharge at the base of the flame and attack with a sweeping movement.

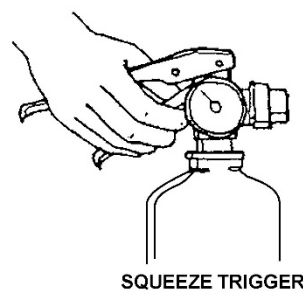
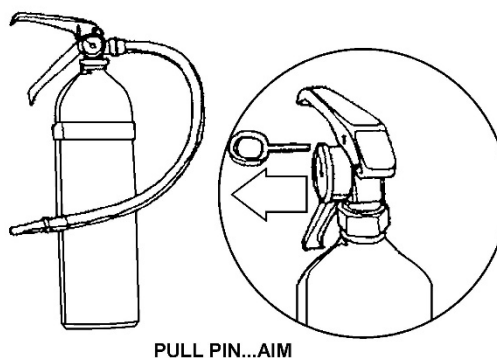

Figure 5-21
Dry Chemical Extinguisher



Fire Suppressions Systems

F.13. Description A fire suppression system is used for extinguishing fires in the engine room where Class B and C fires occur.

F.14. Types There are several types of fixed fire extinguishing systems used aboard various boat platforms, to include: CO₂, Halon, FM-200, HFC-227, and FE-241. These systems are to be used only in emergency situations to control a fire in the engine room space. Refer to specific boat platform Operator's Handbook for detailed procedures on system use.

WARNING 

Ensure all personnel have evacuated the Engine Room before activating the fire suppression system. Activating the system with personnel in the space can result in injury or death.



Section G. Fire Fighting Procedures

Introduction The following paragraphs will explain some safety precautions that must be observed when fighting fire as well as some tactical procedures to follow.

In this Section This section contains the following information:

Title	See Page
Coast Guard's Fire Fighting Duty	5-46
Safety Precautions	5-47
Action	5-48

G.1. Coast Guard's Fire Fighting Duty

Fire Fighting is not a primary mission of the Coast Guard. Because of the limited capability, all fire fighting activities should be limited to only those in accordance with Section 4.4.2.2 of Reference (j). Section 4.4.2.2 states that Coast Guard personnel shall not engage in independent fire fighting operations except to save life, or in the early stages of a fire to prevent a significant threat without undue risk. It also states that for fire fighting activities involving commercial vessels and waterfront facilities, Coast Guard personnel shall not actively engage in fire fighting except in support of a regular fire fighting agency under the supervision of a qualified fire officer.

NOTE

A qualified fire officer is a person who has been trained and certified, under National Fire Protection Association guidelines, to take command of fire fighting operations.

At a waterfront facility, the Coast Guard has special responsibilities and decisions when a vessel or waterfront fire occurs. Decisions made may affect lives, millions of dollars in property, and the free flow of maritime commerce. When determining a unit's assistance posture, the following should be considered:

- (01) Level of the threat of fire.
 - (02) Jurisdictions involved.
 - (03) Capabilities of local fire departments.
 - (04) Availability and capability of Coast Guard equipment.
 - (05) Level of training.
-



G.1.a. Personnel Training Coast Guard personnel engaged in fire fighting operations must be properly trained and equipped for the task they are assigned. Therefore, the level of Coast Guard involvement is dependent upon available leadership, experience, training, and equipment.

Coast Guard planning and training efforts must be integrated with those of other responsible agencies, particularly local fire departments and port authorities. This is especially important for fires on large vessels and shore structures. COTPs work closely with municipal fire departments, vessel and facility owners and operators, mutual aid groups, and other interested organizations. COTPs have developed a fire fighting contingency plan that addresses fire fighting in each port in the COTP zone.

G.2. Safety Precautions

Fire fighting can be very hazardous to anyone involved. Personnel must always be alert and aware of their actions and decisions to avoid being injured or incapacitated. Losing the services of any crewmember may keep a boat crew from preventing other injuries, loss of life, or loss of property. Refer to Reference (h) for a discussion of risk assessment and risk management.

G.2.a. Salvors and Marine Chemists

Shipboard and waterfront fires frequently involve toxic or chemical hazards for fire fighters. These hazards may be the source of the fire or produced as a by-product of fire. Therefore, caution must always be exercised before attempting to fight any type of fire. Requesting trained assistance before becoming involved in fighting a fire of unknown material would be prudent.

Many salvage companies operate over a wide geographic area. Thus, these companies can respond more quickly to these situations. In addition, they employ marine chemists who can obtain temperature readings, check for the presence and concentrations of gases, and can provide information to fire fighting forces about chemical hazards they may encounter during response activities.

G.2.b. Smoke Plumes

Coxswains must always keep their boats well clear of smoke plumes rising from a fire because they greatly reduce visibility and can pose a health hazard. Smoke is a visible product of fire and carries water vapor, acids, and other chemicals produced by fire and can be irritating or toxic when inhaled. A smoke plume is made of suspended particles of carbon and other unburned substances. These products of combustion are released into the atmosphere and travel downwind.



G.2.b.1. Staying Upwind

As a plume expands downwind and outward from a fire, toxic products will be less concentrated. The more toxic a product is, the larger the unsafe area will be, both downwind and to the sides of a plume. The decision to set a perimeter upwind of a toxic smoke or fire plume must be considered and executed when prudent. Individuals who remain a safe distance upwind should not be affected by unseen dangers of a smoke plume.

NOTE 

Generally speaking, remaining upwind of the fire provides a safe area away from toxic hazards that are released in a fire plume.

G.2.b.2. Maintaining a Safe Distance

Other decisions, such as determining a safe distance from a plume of smoke, should be made and constantly re-evaluated as an incident develops. Any change in weather conditions could dictate a need to increase the initial size of a perimeter. A crewmember is considered to be in a danger zone if a smoke plume is visible and radiant heat is felt.

G.2.b.3. Awareness of Gases and Vapors

Smoke plumes also have other factors that must be considered such as the behaviour of gases or vapors that extend beyond a perimeter of visible smoke and fire. Burning plastics and rubber products produce gases, heat, flame, and smoke. These by-products may contain elements of a toxic or lethal nature.

There are many other products of combustion that are dangerous and can be lethal under certain conditions.

G.3. Action

When a boat crew becomes involved in fire fighting operations, the situation will typically be one that fosters a great sense of urgency to extinguish a fire as rapidly as possible. All members of a boat crew must remember that haste and lack of a coordinated effort by boat crewmembers can recklessly endanger a boat and all crewmembers.

G.3.a. Crew Brief

A coxswain must brief crewmembers before arriving at the scene of a fire. This briefing details each crewmember's assignments and emphasizes safety. Crewmembers are responsible for all duties assigned and must request clarification from the coxswain if they do not clearly understand the tasks assigned. They must break out all necessary gear. All personnel must don battle dress before arriving on scene. Battle dress means that everyone will button their collars, roll their sleeves down, wear gloves (if available), and ensure pants are bloused or tucked into their socks. The coxswain is responsible for inspecting all other crewmembers and making certain that battle dress has been donned.



G.3.b. Initial
Action

The following are procedures initially performed when responding to a fire:

Step	Procedure
1	If possible, approach the boat from upwind.
2	Immediately upon arriving on scene, all crewmembers should check the surrounding vicinity for PIWs.
3	Recover and evacuate all survivors to the vessel.
4	Evaluate their physical conditions and render first aid if necessary.
5	If the extent of injury requires more than minor first aid, immediately transport the injured so they can receive professional medical assistance.
6	Inform operational command and EMS if necessary, of the situation.

These procedures are to be taken before attacking the fire, remembering that life comes before property. If there are no survivors or those recovered are in good physical condition and have been evacuated to a safe place, the next step is evaluating the fire.

WARNING 

If the risk of explosion is not certain, back off a safe distance and establish a safety zone. Do not attempt to fight the fire.

CAUTION !

A crewmember's decision regarding his or her role in the overall situation must be constantly reexamined.



G.3.c. Situation Evaluation

The coxswain and crew must evaluate the following elements of the situation:

- (01) Location and extent of a fire.
- (02) Class of fire.
- (03) Class and extent of all cargo involved.
- (04) Possibility of explosion.
- (05) Possibility of any vessel involved sinking/capsizing within a navigable channel.
- (06) Hazard to the crew.
- (07) Maneuverability of the vessel.
- (08) Weather forecast.
- (09) Risk of a serious pollution incident.

Step	Procedure
1	If a fire can be put out with no danger to the crew or the vessel, proceed.
2	If not, back off and maintain a safety zone so that no other vessel comes too close to the fire scene.
3	After completing the initial evaluation, re-evaluate a fire scene/situation frequently. A small fire can rage out of control in minutes and threaten more property and cargo.
4	If a fire must be approached at any time, remember to always approach from windward (Figure 5-22).
5	If it becomes necessary to tie up alongside a burning vessel to fight a fire or to remove survivors, attach only one line to the vessel and keep a sharp knife accessible for a quick break away.

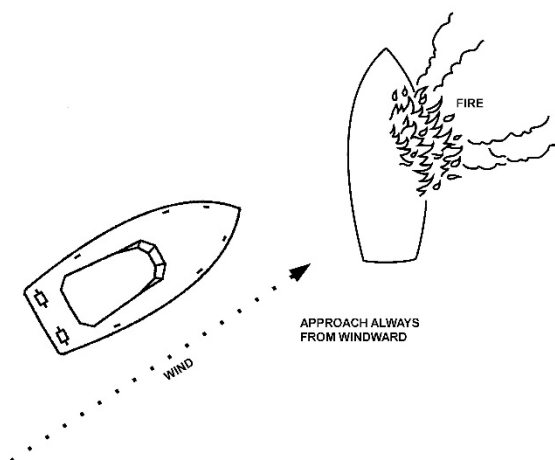

Figure 5-22
Approaching a Boat on Fire



G.3.d.
Overhauling

Danger will still exist even after a fire is believed to be extinguished. The process of overhauling the fire is done to avoid fire re-flash as follows:

Step	Procedure
1	When a fire is out, check for hot spots and set a re-flash watch.
2	When danger of re-flash is no longer a concern, dewater the distressed vessel.



Section H. Extinguishing Fires

Introduction A fire discovered early and quickly fought can usually be extinguished easily. Portable fire extinguishers are used for a fast attack that will knock down flames. However, they contain a limited supply of extinguishing agent. Crewmembers with limited training in using of these extinguishers often waste extinguishing agent by using them improperly. Periodic training, including practice with actual types of extinguishers carried onboard boats, will ensure proficient use of this equipment. Extinguishers that are due to be discharged and inspected should be used for training.

In this Section This section contains the following information:

Title	See Page
Safety Rules	5-52
Fire Combat	5-53
Direct Attack	5-53
Indirect Attack	5-53
Fire Fighting Procedures Onboard Own Boat	5-53
Fire Fighting Procedures on Auxiliary Boats	5-56
Fires Aboard Other Boats	5-58
Fire Under Control	5-58
Fire Extinguished	5-59
Abandoning a Coast Guard Boat	5-59

H.1. Safety Rules The following safety rules should be observed when using portable fire extinguishers:

- (01) Immediately upon discovering a fire, sound an alarm and summon help. Never try to fight a fire alone. Always call for help first.
 - (02) Never pass a fire to get to an extinguisher.
 - (03) If it is necessary to enter a compartment to combat a fire, keep an escape path open. Never let a fire block a door, hatch, or scuttle. Stay low.
 - (04) If extinguishing a fire within a compartment with a portable fire extinguisher fails, get out. Then close the door, hatch, or scuttle to confine the fire.
-



H.2. Fire Combat

An attack should be started immediately to gain control and to prevent extension of a fire to other areas of a boat. An attack will be either direct or indirect, depending on the fire situation. Both methods are efficient when properly employed.

H.3. Direct Attack

A direct attack may be used if a fire is small and has not gained headway. For a direct attack, crewmembers advance to the immediate area of a fire and apply extinguishing agent directly on the fire. Once a fire has gained headway, an indirect attack should be used.

H.4. Indirect Attack

An indirect attack is best when it is impossible for crewmembers to reach a fire. Generally, this is in the lower portions of a boat, such as the engine room and bilge areas. The success of an indirect attack depends on completely containing a fire. Every possible avenue a fire may travel must be cut off by closing doors, hatches, and scuttles and by securing all ventilation systems.

H.5. Fire Fighting Procedures Onboard Own Boat

Every fire will quickly spread to new sources of fuel or oxygen if they are available. However, the path through which a particular fire extends will depend on the location of a fire and the construction of surrounding spaces. These factors must be considered when fighting a fire. In addition, fuel and other combustible products will affect fire fighting operations. For these reasons, no fire can be fought routinely, and all fires must be fought systematically. The following procedures should be part of every fire fighting operation:

CAUTION !

Never fight a fire, however small it may seem, until an alarm has been sounded. Once a fire gains intensity, it spreads swiftly.

Step	Procedure
1	Sound an alarm. Any crewmember who discovers a fire or any indication of fire must sound an alarm and give a location (e.g., “FIRE, FIRE, FIRE IN THE BILGES”).
2	Evaluate a fire. <ul style="list-style-type: none"> (01) Determine the air supply to the fire. (02) Determine the class of fire (combustible material). (03) Determine the fuel source to the fire. (04) Select proper extinguishing agent. (05) Determine method for fighting a fire (direct or indirect). (06) Determine how to prevent spread of a fire. (07) Determine required equipment and crewmember assignments.



Step	Procedure		
3	Determine the need to secure: <ul style="list-style-type: none"> (01) Electrical and electronic power panels. (02) Power to individual electrical and electronic equipment (alternator, radar, inverters). (03) Engine and fuel supply. (04) Air intakes (ventilation system, doors, hatches and scuttles). 		
4	Place all equipment necessary to combat a fire in an open deck area. This includes: <ul style="list-style-type: none"> (01) Portable fire extinguishers. (02) Fire hoses. (03) AFFF. (04) Drop pump. (05) First aid kit. 		
<table border="1" style="width: 100%; border-collapse: collapse;"> <tr> <td style="width: 30%; text-align: center; vertical-align: middle;">CAUTION !</td> <td style="padding: 5px;"> Water can impair the stability of a boat. Make every effort to limit accumulation of water in compartments. Give preference to fog sprays over solid streams of water. Use only as much water as is absolutely necessary. </td> </tr> </table>		CAUTION !	Water can impair the stability of a boat. Make every effort to limit accumulation of water in compartments. Give preference to fog sprays over solid streams of water. Use only as much water as is absolutely necessary.
CAUTION !	Water can impair the stability of a boat. Make every effort to limit accumulation of water in compartments. Give preference to fog sprays over solid streams of water. Use only as much water as is absolutely necessary.		
5	Combat a fire with appropriate extinguishing agent(s).		
6	Notify parent unit at the earliest opportunity. Keep them fully advised of the situation. <ul style="list-style-type: none"> (01) Give position. (02) Nature of fire. (03) Number of POBs. (04) Your intentions. (05) Keep them advised of changing situation and status of personnel. 		



Step	Procedure
7	<p>Overhaul the fire.</p> <ul style="list-style-type: none"> (01) Once the fire has been extinguished, the spaces involved must be properly ventilated to remove any smoke, explosive, or toxic gases. If there is any doubt as to whether the space might contain harmful fumes, do not enter that compartment. Return to the Station and have the space checked out by trained officials. Be careful when ventilating because the introduction of fresh air into a compartment might cause the fire to re-flash. (02) Once in the space, inspect all overhead spaces, decks, and bulkheads. (03) Check where wiring and piping penetrates through bulkheads and decks. (04) Expose areas that are charred, blistered, or discolored by heat until a clean area is found. (05) Pull apart and examine any materials that might have been involved with the fire for hidden fire and hot embers. Jettison (throw overboard) all such material if necessary. (06) Set a re-flash watch. One crewmember must be assigned to do nothing but check for re-ignition and to sound an alarm if it occurs.
8	<p>Re-stow all fire fighting equipment except those pieces that are being used by the re-flash watch.</p> <ul style="list-style-type: none"> (01) Recharge or replace portable fire extinguishers, even if only partially used, immediately upon arrival back at the unit. (02) Swap out used fire hoses with spare dry hoses. Drain, clean, dry, and roll up used hoses for storage.
9	<p>Conduct a damage control check. Start any necessary dewatering operations. Depending on the severity of the damage, it might be best to tow the damaged vessel back to port where an in depth determination concerning damage to the vessel's systems can be conducted. Utilizing possibly damaged electrical or mechanical equipment might cause further damage or another fire.</p>



H.6. Fire Fighting Procedures on Auxiliary Boats

Use the following procedures when battling a fire on an Auxiliary boat:

Step	Procedure
1	When a crewmember becomes aware of an engine compartment fire, shut off all engines, generators, and ventilation systems.
2	If boat is equipped with an automatic extinguishing system, ensure it is discharging. If the system is manually operated, energize it and check to ensure it is discharging.
3	Initiate a MAYDAY call to alert boats in the area of the situation.
4	Have all crewmembers don PFDs and everyone move to a smoke-free and flame-free area of the boat.
5	If a life raft or dinghy is available, put it over the side and inflate it, if necessary.
6	(01) If boat has a built-in CO ₂ system, after fire is out, allow time for concentrations of CO ₂ to ventilate to the atmosphere before entering the compartment. (02) On boats fitted with a Halon system, the dangers of toxic gases are not as great when entering the compartment, but always enter with caution. Never enter a compartment after a fire until you are sure it has been properly ventilated.



I.6.a. Opening a Hatch

The possibility of burned hands and/or a singed face can be expected if someone must open a hatch to discharge a portable extinguisher. As the fresh air enters the compartment, it will feed the fire, and cause it to “blow up.” The best method of opening a hatch is to stand to the hinged side of the hatch. Then while wearing gloves or using something other than bare hands, the hatch can be pulled open. If the boat has a closed engine compartment, no fixed system, and is equipped with an access hole/plug (Figure 5-23), a portable extinguisher may be discharged through this hole.

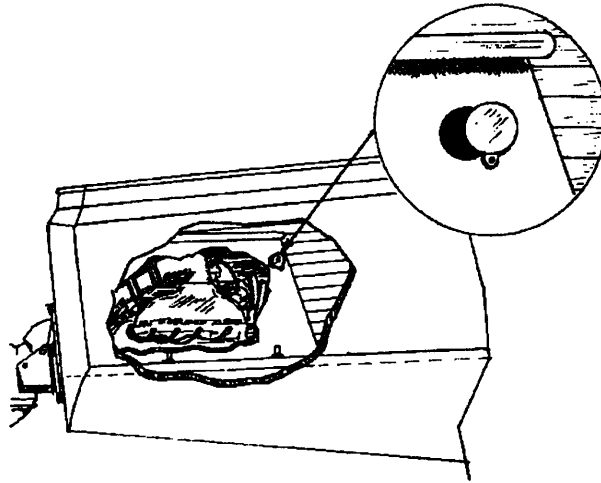

Figure 5-23
Access Hole/Plug for Extinguishing the Engine Compartment



H.7. Fires Aboard Other Boats

Use the following procedures when battling a fire aboard other boats to effect rescue of personnel:

Step	Procedure
1	Brief crewmembers on appropriate procedures.
2	Assign each crewmember specific duties.
3	While en route to the scene, establish communications with the distressed boat.
4	Approach the boat from upwind.
5	If no one is onboard, circle the boat (at a safe distance) searching for PIWs.
6	Advise all persons aboard the boat to move to a flame and smoke-free area, topside.
7	Attempt to determine the extent and source of the fire. If it is not obvious, ask the personnel aboard the distressed boat where the fire is located.
8	If the fire is beyond the crewmembers fire fighting capabilities, evacuate the persons from the distressed boat and call for assistance.
9	Check the physical condition of the survivors. If medical treatment is required, proceed to the nearest location where medical help can be administered.
10	If the fire is small and within the crewmember's capabilities, first ensure that the survivors are safe on the boat, another boat, or ashore before attempting to fight the fire.
11	After assessing the situation, fight the fire with the fire fighting equipment available. Avoid placing the crew and transferred survivors in any danger.

H.8. Fire Under Control

Under the following circumstances, a fire may be considered to be under control:

- (01) Extinguishing agent is being applied to a fire and has effectively begun to cool it down.
- (02) The main body of a fire (base) has been darkened. At this point, a fire cannot generate enough heat to involve nearby combustible materials.
- (03) All possible routes of fire extension have been examined and found safe or protected.



H.9. Fire Extinguished

Before a fire can be declared completely out, ensure the following actions have taken place:

- (01) A thorough examination of the immediate fire area has been conducted.
- (02) A complete overhaul of all burned material has been accomplished.
- (03) A re-flash watch has been set.
- (04) All fire fighting equipment has been restowed with the exception of what is being used for the re-flash watch.
- (05) A damage control check has been performed.
- (06) All crewmembers have been accounted for.

When possible, these activities should be conducted by local fire fighting professionals

H.10. Abandoning a Coast Guard Boat

Crewmembers should not panic and hastily abandon a boat even when a fire is severe. Instead, they should stay calm while using equipment and training to combat the fire. Abandoning the boat should only be considered as a last resort once all available options for extinguishing the fire have been attempted. Aggressive and proficient fire fighting is normally a preferred alternative to abandoning a boat, however, crewmembers should not hesitate to abandon the boat if the following conditions exist:

- (01) Becoming trapped by the flames.
- (02) There is no longer the equipment to fight the fire.
- (03) An explosion is likely (flames by the fuel tanks).
- (04) Similar life threatening situations are apparent.

If able, the coxswain should inform OPCON of location and any other pertinent information. Make sure that:

- (01) Distress call has been initiated.
 - (02) All personnel are wearing life jackets.
 - (03) Life raft or dinghy is put over, if available.
 - (04) Portable radio is taken.
 - (05) Extra signaling gear is taken.
-



CHAPTER 6

Air Operations

Introduction Coordinated operation between boats and aircraft creates a valuable team for maritime missions. As a boat crewmember, there will be many opportunities to work with helicopters. Every opportunity should be taken to become familiar with the operations of the nearest local Coast Guard Air Station or other agency (e.g., Navy, Army, Air Force, National Guard, or OGA).

Boat operations with aircraft usually involve transfer of a person or equipment between a helicopter and a boat. Sometimes, a boat must coordinate with an airplane. Reference (j) has a list of capabilities and deliverable SAR equipment for each type of Coast Guard aircraft. Boat crews need to be aware that aircraft (Coast Guard, Auxiliary, OGA or some civilian OGA) might try to contact and operate with them.

In this Chapter This chapter contains the following sections:

Section	Title	See Page
A	Helicopters and Equipment	6-2
B	Helicopter Rescue Operations	6-9
C	Helicopter Ditching	6-27
D	Fixed-Wing Aircraft	6-31

WARNING

The wearing of jewelry, including rings, wristwatches, necklaces or other items not consisting of organizational clothing, PPE, or uniform articles by boat crew members engaged in hoisting, towing, or other deck evolutions where the potential for snagging exists **is prohibited**. OICs and coxswains will address this during all pre-underway briefs and coxswains shall ensure jewelry is removed prior to beginning all deck evolutions.



Section A. Helicopters and Equipment

Introduction

Excellent multi-mission capabilities are available in the Short-Range Recovery (SRR) helicopter MH-65 and the Medium-Range Recovery (MRR) helicopter MH-60. Helicopter maneuverability and outstanding crew visible scanning capabilities enable the crew to closely inspect sightings and search shorelines. They are flexible rescue platforms, capable of recovering people from a wide variety of distress situations on land or water. Both helicopters can:

- (01) Hover,
- (02) Deploy rescue swimmers/EMTs or civilian divers;
- (03) Perform hoists using a rescue basket, stokes litter, or rescue strop,
- (04) Deliver equipment (e.g., dewatering pump and fire suppression kits) when available,
- (05) Deploy datum marker buoys,
- (06) Search with radar,
- (07) Provide night illumination,
- (08) Direction finder,
- (09) Perform multi-mission patrols,
- (10) Conduct supply/replenishment operations.

NOTE

Both aircraft have night vision goggles, and the HH-60J has forward-looking infrared capabilities.

In this Section

This section contains the following information:

Title	See Page
MH-65 Dolphin	6-3
MH-60 Jayhawk	6-4
Helicopter Equipment	6-5
Trail Line	6-7
Weak Link	6-8
Dewatering Pump Kits	6-8



A.1. MH-65 Dolphin

The MH-65 “Dolphin” has two turbine engines that will produce a maximum airspeed of 175 knots (see **Figure 6-1**). The normal crew is one or two pilots and a flight mechanic. For rescue missions, a rescue swimmer is normally carried in addition to the three crewmembers. The flying pilot during hoisting operations sits in the right seat of the cockpit. Other general information includes:

- (01) Maximum endurance with a crew of two pilots and one crewmember is approximately three hours.
- (02) Maximum of four passengers or survivors (besides crew) can be carried.
- (03) Hoist capacity is 600 lbs. and the external cargo sling limit is 2,000 lbs.
- (04) It will not land on the water except in an emergency. It will float if it is not badly damaged and the flotation bags are deployed.



**Figure 6-1
MH-65 (Dolphin) Helicopter**



A.2. MH-60 Jayhawk

The MH-60 “Jayhawk” has 2 turbine engines that, depending upon the gross weight of the helicopter, will produce a maximum airspeed of 180 knots (**Figure 6-2**). Although equipped with two engines, the MH-60 can normally maintain hover with one engine (the loss of one engine is considered an emergency situation). The normal crew is two pilots and two crewmembers. For rescue missions, a rescue swimmer is normally carried in addition to four crewmembers. Other general information includes:

- (01) Maximum endurance of the aircraft with maximum fuel and crew is approximately six hours.
- (02) Hoist capacity is 600 lbs. and the external cargo sling limit is 6,000 lbs.
- (03) The MH-60 is not capable of landing on the water and is not equipped with flotation bags.



Figure 6-2
MH-60 (Jayhawk) Helicopter



A.3. Helicopter Equipment

Hoists by Coast Guard helicopters will normally be done with the following rescue devices and equipment.

A.3.a. Rescue Basket

The multi-jointed (M/J) rescue basket is the primary device for hoisting survivors from land or sea during helicopter rescue operations. It provides protection for the individual being hoisted from dangers, such as striking vessel rigging. It has the capability to float. Hinged at all four corners, it folds inward ([Figure 6-3](#)) and ([Figure 6-4](#)). The basket is employed for personnel transfer in any weather condition.



Figure 6-3
M/J Rescue Basket Unfolded Position

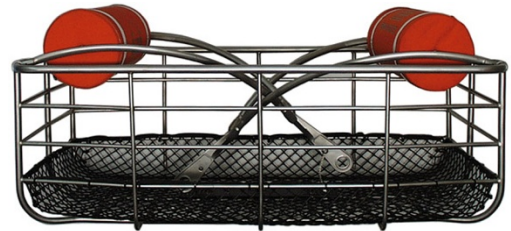

Figure 6-4
M/J Rescue Basket Folded Position



A.3.b. Stokes Litter

The stokes litter is a stretcher with a flotation collar and chest pad for buoyancy. A 5-pound ballast weight located at the foot end provides stability. A permanently mounted hoisting sling attaches the litter to the helicopter hoist cable. For restraining patients, five securing straps, including chest pad, are supplied.

The stokes litter is used to transfer an injured or unconscious person in any weather condition. It is generally used when the patient's condition prevents use of the basket. When the patient is placed in a litter, a crewmember must tighten all straps to keep the person securely bound to it. There are five straps, as shown in (Figure 6-5).

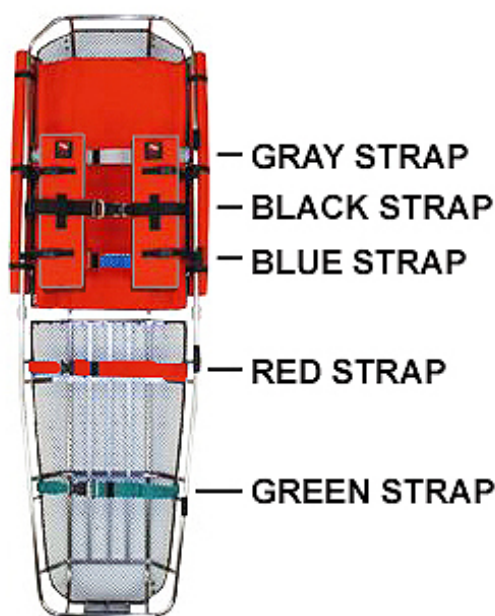

Figure 6-5
Stokes Litter



A.3.c. Rescue Strop

The rescue strop (**Figure 6-6**) is used only to rescue persons familiar with its proper use, for example, a military aviator. It can handle one survivor wearing the usual flight gear and PFD.

NOTE 

Use of chest retainer strap is mandatory during use of the rescue strop, except when hoisting rescue swimmers.



Figure 6-6
Rescue Strop

A.4. Trail Line

Use of a trail line minimizes the time a pilot must maintain a precise stable hover without a reference point. The trail line consists of 105 feet of orange polypropylene line with a weak link and snap link at one end, and a snap hook at the other. A 5-pound (or heavier) bag is attached to the trail line snap hook for ease in delivery of the trail line. When used, the trail line will:

- (01) Stabilize a rescue device to prevent sailing, swinging, and possibly becoming fouled.
- (02) Reduce the time a pilot must maintain a precise hover.
- (03) Reduce time on-scene.
- (04) Allows the flying pilot to offset laterally and maintain a visual reference with the boat.



A.5. Weak Link

The weak link (**Figure 6-7**) is a safety device between the trail line and hoist hook, which protects the helicopter by not allowing more than 300 pounds of force to be applied to the hoist. If more force is applied, the weak link will part. If the weak link parts, crew members should be prepared for a portion of the trail line to “snap back.”

WARNING

The weak link is not designed to protect crewmembers from injury. 300 pounds of force is more than sufficient to cause severe injury or death.

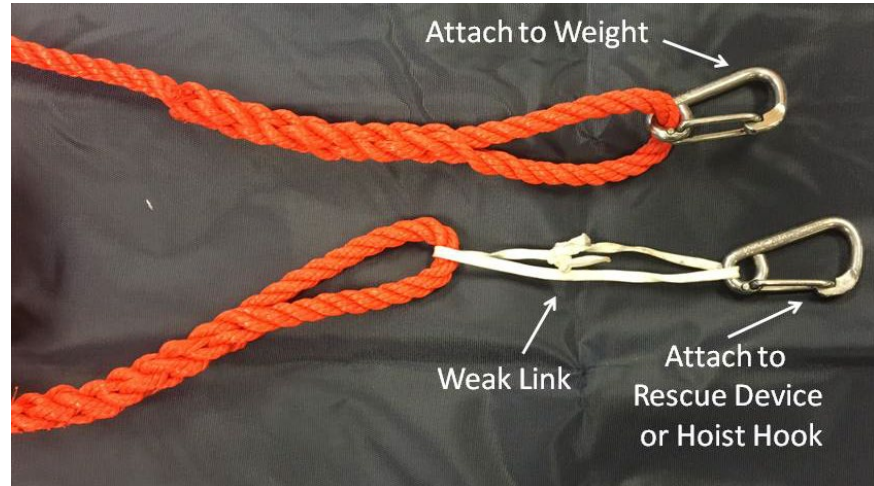

Figure 6-7
Trail Line's Weak Link

A.6. Dewatering Pump Kits

Dewatering pumps provide emergency dewatering for boats in danger of sinking. Under a load, the pump will run 4 to 5 hours on one gallon of gasoline. The pumps are designed to fit into a standard round aluminium container and it is deployable.

WARNING

Coast Guard dewatering pumps will not be used to pump flammable liquids.



Section B. Helicopter Rescue Operations

Introduction This section discusses the procedures and necessary safety precautions involved in a helicopter rescue operation.

In this Section This section contains the following information:

Title	See Page
Rescue Swimmer	6-9
Helicopter Hoisting Operations	6-9
Helicopter-Boat Positioning	6-16
Delivery of the Rescue Device	6-19
Hoisting	6-22

Rescue Swimmer

B.1. Description The rescue swimmer (RS) is a properly trained and conditioned certified EMT. The RS is trained to deploy from a helicopter to recover an incapacitated victim from the maritime environment, day or night. Since a helicopter has weight and space limitations, a boat may be requested to recover an RS. The RS is equipped with a strobe light and signal flares.

Helicopter Hoisting Operations

B.2. Description Helicopter hoisting operations off of a vessel can pose great hazard to the aircrew, boat crew, and to whatever is being hoisted. The safety and efficiency of helicopter hoist operations is greatly improved if the crew of the vessel is briefed in advance on what is required.

Boat-helicopter operations require a team effort, alertness, and cooperation among crewmembers aboard both the boat and helicopter. Since the noise level may hinder communications, the coxswain and pilot usually plan the operation before the helicopter is overhead. Once the helicopter is in position, the air crewmember serving as hoist operator gives the pilot maneuvering instructions for guiding the rescue device to the boat deck below. Specific guidelines for the boat crew are discussed below.

WARNING

Safety is always a primary consideration. Anytime the boat coxswain or helicopter pilot feels the operation is unsafe, it should be broken off and, if practical, begun again.



B.3. Boat Crew Preparations for Hoisting

Before the helicopter arrives, the coxswain will complete action on the following general categories of preparation:

- (01) Navigation,
- (02) Communications,
- (03) Protective gear,
- (04) Loose gear,
- (05) Snag Hazards,
- (06) Hand signals,
- (07) Briefing crew.

If radio communications are lost and an emergency breakaway is required, the boat's blue emergency light or other emergency signal should be used to signal the breakaway to the helicopter.

NOTE

The U.S. Coast Guard uses the term "hoist," while the international community uses the term "winch."

B.3.a. Navigation

Check charts for hazards that would prevent the boat from maintaining course and speed until the hoist is complete.

B.3.b. Hoisting Operations at Night

Conducting hoisting operations at night can be challenging but proper preparation can help ensure a safe evolution. Since the radar gets secured, prior to securing radar, check for contacts that could pose a risk along intended course. When conducting hoisting operations at night, the boat's navigation lights (side, masthead, or stern) may cause disorientation for pilots or obscure the vision of pilots using night vision devices. For example, when the helicopter is approaching from astern, the stern light can be intermittently obstructed by the flags creating a strobe-like appearance that can be very distracting. During these operations, the helicopters lights provide a clear and conspicuous visual warning to local mariners operating in the vicinity. After conducting an operational risk management discussion with the helicopter, coxswains may extinguish the boats navigation lights during helicopter hoisting operations



B.3.c. Communications are established with the helicopter as early as possible to exchange information and instructions. This includes:

Communications

- (01) Use of primary and secondary working frequencies.
- (02) On-scene weather (estimated wind speed and direction as well as sea state).
- (03) Exact position.
- (04) Condition of persons, if any, requiring medical attention.
- (05) Any information to aid the pilot in selecting the rescue device.
- (06) Total number of crew and other persons onboard the boat, and total number onboard the helicopter.
- (07) Conduct hoist briefing with the helicopter pilot.

Communications between crew members is difficult due to the noise created by the helicopter. When possible, use of a boat crew communication system (BCCS) is highly encouraged. When use of a BCCS is not possible, crew members will find themselves having to yell to communicate with each other due to the noise from the helicopter.

B.3.d. Protective Gear All protective gear is properly worn, including:

Protective Gear

- (01) Head (helmet), eye (goggles) and hearing protection shall be worn.
- (02) Protection for hands (gloves) is optional. If worn they should be as form fitting to the hand as possible to reduce the possibility of becoming fouled with any of the hoisting equipment.
- (03) PFDs, anti-exposure coveralls, and dry suits (depending on weather conditions).

B.3.e. Loose Gear

All loose gear is stowed or secured on deck (e.g., hats, cushions, life rings, etc.).

B.3.f. Cable Management/
Snag Hazards

The air crew is responsible for managing the cable. The amount of slack in the cable should be enough to avoid sudden and unintended tension while minimizing the opportunity for snags and/or injuries to the boat crew. In the event of excessive slack, the boat crew must be prepared to assist in managing the cable to the extent that it does not snag on the boat or pose a risk of injury to the crew. If excess cable causes an unsafe condition, attempt to clear the cable away from personnel and snag hazards and notify the aircrew using the “unsafe condition” hand signal.

WARNING 

Do not coil the hoist cable in the rescue basket or stokes litter.



B.3.g. Hand Signals

One boat crewmember is designated to give hand signals to the hoist operator. Communication between boat crewmembers on deck should occur prior to giving a hand signal to the helicopter. For example, once a rescue device is on deck, prior to giving the thumbs up signal for device removal, check with other crewmembers to make sure they are ready to proceed. The hand signals authorized for communications between the boat and helicopter are below (Figure 6-8, counter clockwise, starting from top-left):

- (01) Ready to Proceed,
- (02) Unsafe Condition,
- (03) Not Ready,
- (04) Intention to jettison device.





U.S. COAST GUARD BOATCREW HAND SIGNALS			
SIGNAL	MEANING	SIGNAL	MEANING
 <p>RIGHT ARM HELD LEVEL WITH SHOULDER, THUMB UP.</p>	READY TO PROCEED	 <p>EITHER ARM AND HAND LEVEL WITH SHOULDER; HAND MOVING ACROSS THROAT, PALM DOWNWARD. THE HAND IS MOVED SIDEWAYS WITH THE ARM REMAINING BENT.</p>	INTENTION TO JETTISON DEVICE
 <p>VIGOROUS WAVING OF RIGHT ARM.</p>	UNSAFE CONDITION	 <p>RIGHT ARM HELD VERTICALLY, WITH FIST GLENCHED.</p>	NOT READY

Figure 6-8
Hand Signals Between Boat and Helicopter

B.3.g.1. Hand Signals – Ready to Proceed

When ready to proceed, the boat crewman designated to give hand signals shall raise their right arm level with the deck and extend the “thumbs up” to the hoist operator. The crew member should check with other crew to ensure they are ready to proceed. Examples of when to use this signal are as the helicopter approaches the boat to signal “ready on deck” and to inform the hoist operator that the device can be retrieved from the deck of the boat.



B.3.g.2. Hand Signals- Unsafe Condition

When an unsafe condition exists, the boat crewman shall notify the hoist operator by vigorously waving their right arm from the top of their head to a point level to deck with their fingers fully extended for maximum visibility. Examples of unsafe conditions are trail line/hoist cable or rescue device entanglement with a crewman or with the boat (snag hazard). When this signal is given the crew need to correct the unsafe condition if possible to do so. Additionally, the hoist operator needs to actively manage the hoist cable and provide conning direction to the flying pilot to prevent the unsafe condition from getting worse. The coxswain should always be made aware of any unsafe condition in case there is a need to perform an emergency breakaway.

B.3.g.3. Hand Signals- Not Ready

When the boat crew is not ready for hoisting operations, the boat crewman shall notify the hoist operator by fully raising their right arm vertically with a clenched fist. An example of this signal is when the helicopter is approaching the boat, but the crew on deck are not prepared to proceed with the evolution.

B.3.g.4. Hand Signals-Intention to Jettison Device

If the crewmember intends to jettison the device, the crewmember will notify the hoist operator by raising their arm and hand (left or right) level with their shoulder and move their hand (palm down) across the throat sideways with the arm remaining bent in a classic “cut it” gesture. Once this hand signal is given, the crew should place the device over the side (usually port). Always ensure that the coxswain is aware of the intention to jettison the device.

B.3.h. Briefing Crew

The crew and person(s) to be hoisted are briefed regarding the type of hoist to be expected (e.g., basket, litter, or strop).

WARNING 

A helicopter in flight builds up static electricity that can be transferred to the boat crew through the hoisting cable, rescue device, and trail line. Crews shall ensure that any device lowered from a helicopter is allowed to come in contact (ground) to the boat, water, or a “Deadman’s Stick” (static discharge wand), before touching it.

WARNING 

The downwash of a helicopter is very powerful. It can blow a person overboard. It can also blow loose gear over the side. Loose objects such as articles of clothing can be caught in the air currents produced by the rotor blades and sucked into the engines.

WARNING 

Never attach, tie, or secure anything to the boat that is also attached to the helicopter.

B.4. Boat Crew Positions on Deck

Helicopter hoisting operations require a great deal of coordination and effort between the boat crew and air crew. Under normal circumstances, there are usually a minimum of 3 crewmembers on deck, crewmembers number one, two and a safety observer. At times the coxswain may determine a need for more crew on deck and at times less.



B.4.a.
Crewmember # 1

Crewmember number one (BCM1) completes the following:

- (01) Communicates with hand signals to the helicopter,
- (02) Uses the grounding wand to ground the rescue device,
- (03) Makes initial contact with the device being lowered to the boat,
- (04) Acts as the primary manager of the rescue device on deck,
- (05) Clear snags and fouled devices as appropriate,
- (06) Acts as primary manager for loading survivors into rescue device.

B.4.b.
Crewmember # 2

Crewmember number two (BCM2) assists crew member one. He or she will assist by:

- (01) Observes hand signals between BCM1 and helicopter,
- (02) Tending trail line on deck – always mindful of entanglement threat to body or snag hazards,
- (03) Clear snags and fouled devices as appropriate,
- (04) Assist BCM1 with rescue device if needed,
- (05) Assist with loading survivors in rescue device.

B.4.c. Safety
Observer

An attentive Safety Observer (SO) is part of an effective risk control process used on the boat during helicopter operations. While the coxswain is always in charge of the boat, it can be difficult to see the entire hoisting evolution while maintaining proper course, speed and radio communications, the safety observer acts as the coxswain's eyes on deck ensuring that the hoisting evolution is safely executed. The safety observer:

- (01) Takes position on deck for best trade off of visual observation, team communication while limiting interference (**Figure 6-10**),
- (02) Observes hand signals between BCM1 and BCM2,
- (03) Observes on deck performance, to include:
 - a) Stopping the incorrect use of tended trail lines, rescue devices and/or hoist cable,
 - b) Identify deck hazards (e.g., bights, loops, snag hazards).
- (04) Acts as communication conduit between deck personnel/coxswain via BCCS (if applicable),
- (05) Post Hoist - Provides feedback to crew and coxswain for improved performance on deck.



**B.4.d. Limited
Crew
Availability**

In some cases there may be times when a crew of only three are underway, if this is the case, the coxswain must make a determination about the need to conduct a hoist. If deemed necessary consider these options:

- (01) Utilize rescue swimmer from helicopter (if applicable) to help load patient/survivor.
- (02) Assign BCM2 as Safety Observer and conduct hoist.
- (03) Coxswain acts as the safety observer (DIW hoist).

**B.5. Boat Crew
Safety
Precautions**

During the hoisting evolution, safety is paramount. All boat crewmembers should observe the following safety precautions:

- (01) A helicopter in flight builds up static electricity that can be transferred to the boat crew through the hoisting cable, rescue device, and trail line. Crews shall ensure that any device lowered from a helicopter is allowed to come in contact (ground) to the boat, water, or a “Deadman’s Stick” (static discharge wand), before touching it.
- (02) Trail lines, the rescue device and hoist cable shall be tended by hand to keep them clear of personnel, the boat’s rigging and any other snag hazards. Never attach them to the boat.
- (03) Minimize handling the hoist cable to the maximum extent practical. Unless required to handle the rescue device or to sweep the cable away from personnel, rigging or other snag hazards, boat crew should not handle the hoist cable. This allows the flight mechanic to effectively manage the amount of slack in the cable.
- (04) Do not coil the cable in the rescue device.
- (05) If excess cable causes an unsafe condition, notify the hoist operator via the unsafe condition and attempt to clear the device.
- (06) Always wait for slack in the hoist cable before attempting to hook onto the device to be hoisted. This precaution allows for relative motion between helicopter and boat.
- (07) Always unhook the rescue device before moving it inside the boat.
- (08) Never stand between the rescue device on deck and the aircraft. If for some reason the hoisting cable went taught the rescue device could be pulled overboard very quickly.
- (09) Never stand over the rescue device.
- (10) Never place hands in/between the grates of a rescue device – this can lead to a serious mishap.
- (11) Always face the aircraft when the rescue device is in the vicinity of the boat.



Helicopter-Boat Positioning

B.6. Description When working with a helicopter at night, crewmembers must never shine a light towards or take flash pictures of the helicopter. The sudden light may temporarily blind or disorient the pilot.

Pyrotechnics or illuminating signals must never be used without first contacting the pilot.

B.7. Course and Speed

Hoists from standard boats are normally made from the stern. The pilot normally will direct the coxswain to assume a certain course and speed with a relative wind speed of 15 to 30 knots and 35°-45° off the port bow (**Figure 6-9**). Sometimes, sea conditions may require departure from this rule, especially to minimize boat rolling. The boat must maintain a steady course and speed.

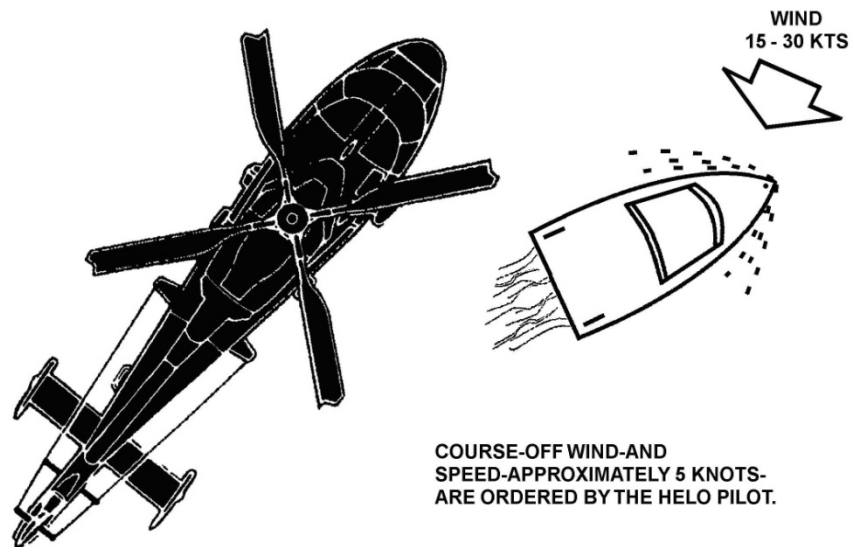

Figure 6-9
Helicopter-Boat Hoist



B.8. Nonstandard Boats

Hoisting from nonstandard boats for training is not preferred and presents potential issues for the helicopter and boat. Hoists from non-standard boats, Auxiliary craft or OGA's may require a different technique. The helicopter will maintain a steady course and speed while lowering the rescue device to a point below the aircraft near the surface. The boat should approach and maneuver under the hoist for delivery. This method of conducting a hoist should be done only in an emergency situation and must always be discussed between the boat operator and aircraft commander prior to execution.

B.9. Helicopter-Boat Configuration

The rescue device will be lowered from the right side of the aircraft. The helicopter will approach the boat from astern (downwind) and hover off the stern/port side. This method of approach allows the pilot and hoist operator (located on the right side of the aircraft) a full view of the boat during the evolution (**Figure 6-10**).

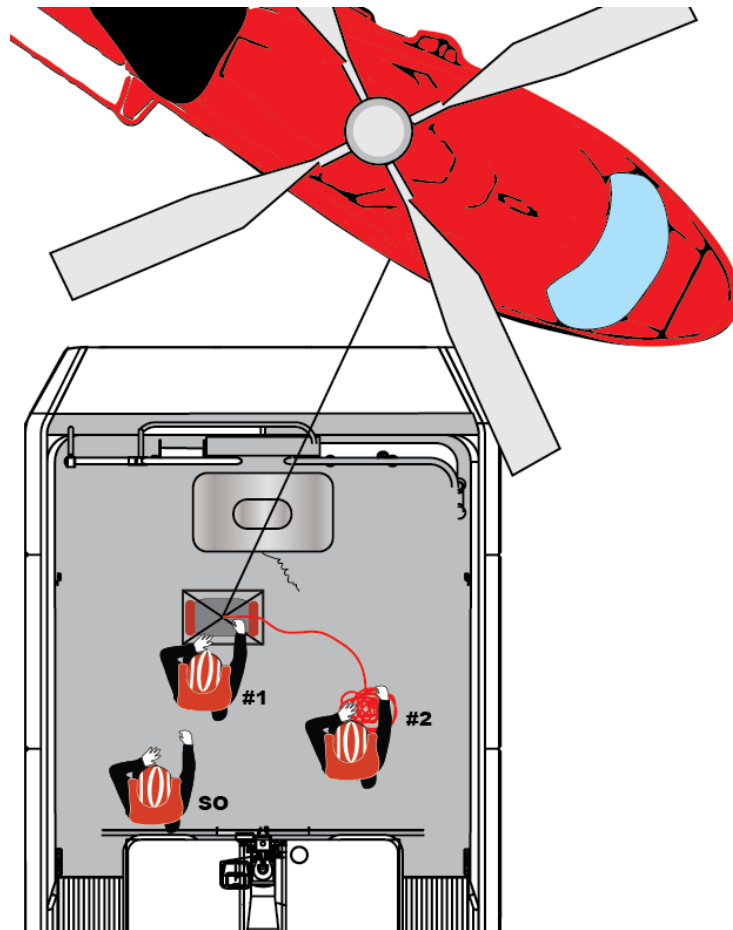

Figure 6-10
Overhead View of Deck Personnel, with M/J Basket and Trail Line



B.10. Dead-in-the-Water

When a boat is dead-in-the-water (DIW), the helicopter may approach the boat's bow or starboard beam (**Figure 6-11**). Due to the downwash, the boat will almost always turn clockwise and the aircraft will maintain visual contact by turning in the same direction during the hoist. On smaller platforms, the helicopter will have some control over the vessel by using its rotor wash.

Coast Guard helicopters use different approaches for different styles of vessel if they are DIW. The approach will also vary depending on where the working deck will be. Most Coast Guards boats will work off the stern while some fishing vessels might work off the bow since their stern area contains equipment that could foul the hoist cable. Boat crews must always communicate with the helicopter before a hoisting evolution to ensure both parties know the plan. Once hoisting has begun, the helicopter will almost always remain off the starboard side of the boat.

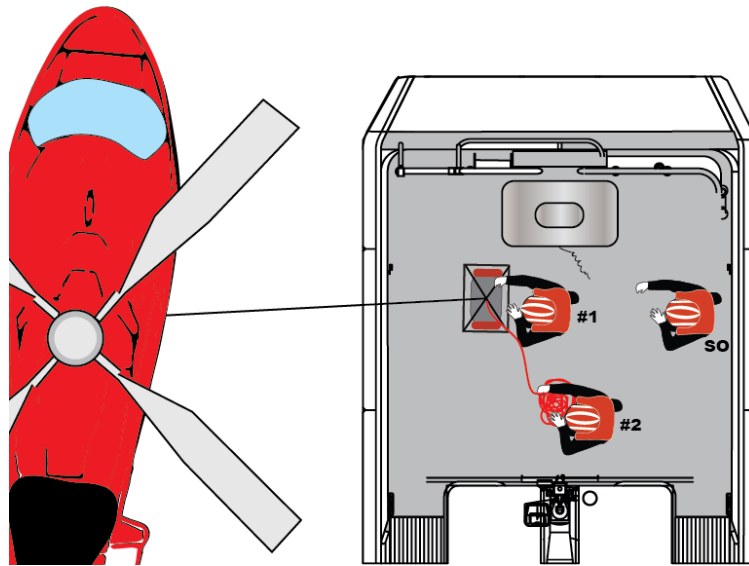

Figure 6-11
Overhead View of Crew Positions During DIW Hoist



Delivery of the Rescue Device

B.11. Description Delivery of a rescue device from the helicopter to a vessel in distress or for training will be accomplished by one of the following three methods:

- (01) Direct delivery.
- (02) Trail-line delivery.
- (03) Indirect delivery.

After the rescue device is delivered (and if previously agreed to in the aircraft brief), a boat crewmember will disconnect the hook before moving away from the delivery/hoisting location. The cable may be re-attached to the device at a time agreed upon with the helicopter pilot.

WARNING 

Never attach the hook to any part of the boat.

B.12. Direct Delivery

During direct delivery, the rescue device is lowered directly to the deck of the vessel. The boat crewmember tending the lowered piece of equipment should allow the hoist operator to keep the hoist cable as plumb as possible to avoid swinging of the rescue device.



B.13. Trail-Line Delivery

During trail-line delivery, a 5-pound or heavier weight bag is attached to the trail line and lowered from the helicopter to the vessel. The helicopter will then back off to a safe hoisting distance while paying out the trail line. The non-weighted end of the trail line is attached to the rescue device (weak link first) and lowered to the vessel (**Figure 6-12**). Boat crewmembers will tend the trail line by hand-over-hand method, exerting enough strain to guide the rescue device to the delivery point on deck. Too little strain causes the device be lowered nearly vertical (plumb) which makes device management more difficult for both the hoist operator and crew on deck. The crew on deck then have to work harder to pull the device toward the boat. Placing enough strain on the trail line allows for the device to be tended more diagonally and allows for an easier evolution. As the hoist operator pays out slack, continue to haul in on the trail line to avoid the device from being lowered vertically. A second crewmember (Crew 2) will assist the crewmember (Crew 1) hauling in the trail line by coiling the trail line in a safe place on deck ensuring the line does not get fouled around an object or get blown overboard.



Figure 6-12
M/J Rescue Basket Going Down



B.14. Indirect Delivery

Indirect delivery is designed for delivery of a portable dewatering pump. The trail line, weighted bag attached to the weak link first, is delivered from the helicopter to the vessel. The helicopter will pay out the trail line as the helicopter backs off and establishes a low hover with the rotor blades and downwash clear of all rigging (**Figure 6-13**). The hoist operator will then attach the end of the trail line to the pump container and deploy it to the water (**Figure 6-14**). The boat crewmember will then pull the pump aboard.

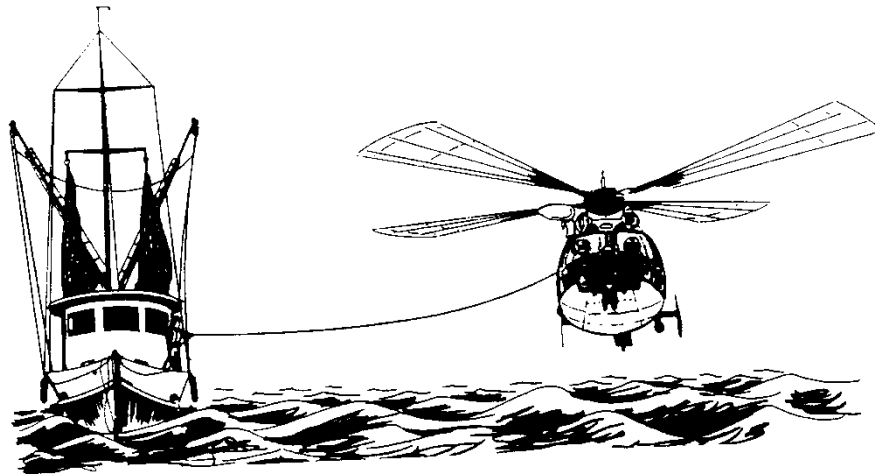

Figure 6-13
Indirect Delivery of Pump

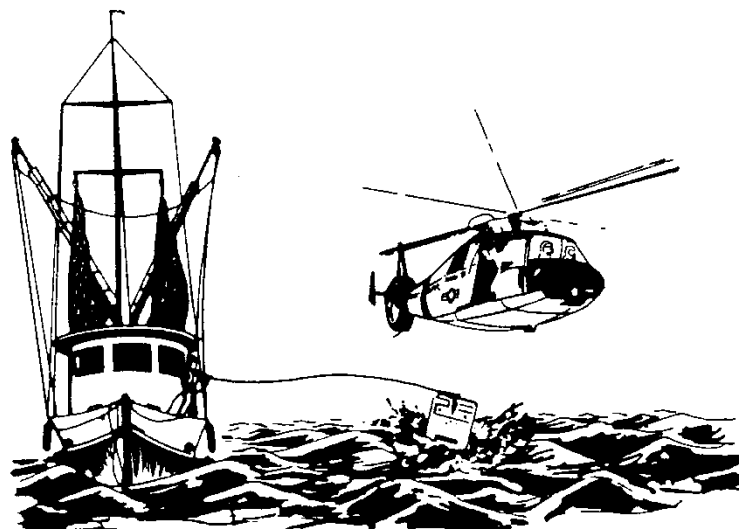

Figure 6-14
Pump in the Water



Hoisting

B.15. Description Hoisting is the transfer of a person(s) or equipment between a boat and helicopter. Helicopter hoisting operations off a boat can pose a great hazard to the aircrew, boat crew, and the person or equipment being hoisted. A safety brief will be conducted prior to any hoisting operation to discuss the duties and responsibilities of every boat crew member. Close coordination between the coxswain and the helicopter pilot are essential for a successful hoisting evolution. Rigging and use of the proper piece of equipment (M/J rescue basket, stokes litter, rescue strop, drop pump, etc.), visual communication (hand signals) between the helicopter rescue hoist operator and boat crew member, and verbal communication between the rescue hoist operator and helicopter pilot will safely guide the equipment to the boat deck during delivery and ensure its safe return to the helicopter as it is retrieved.

CAUTION!

Helicopter rescue baskets are collapsible. Boat crewmembers should not connect or disconnect the hoist cable from the rescue basket.



B.16. Basket Hoist

Every person transferred must wear a PFD and head protection, if available. The person must be positioned in the basket with hands placed palms up under the thighs. This position will keep the arms tucked in close to the body and inside the basket. The crewmember assisting the person into position must ensure that no part of the person's body is outside of the basket and that the basket does not hang up on equipment attached to the boat. When the individual to be hoisted is in the proper position, the boat crewmember will give the "thumbs up" to the hoist operator, who will commence the hoist (**Figure 6-15**). If a trail line is used, it should be tended hand-over-hand over the side. When the end is reached, the weighted bag is gently released.



Figure 6-15
M/J Rescue Basket with Person Properly Positioned and Ready for Hoist



B.17. Stokes Litter Hoist

The Stokes litter used for hoisting will be provided by the helicopter. When the victim is placed in the litter, a boat crewmember must tighten all restraining straps around the person. There are four straps and one chest pad. The crewmember tending the litter must make certain it does not get hung up on boat equipment. When the person is to be hoisted, boat crewmember 1 will give a “thumbs up” to the hoist operator, who will commence the hoist. If a trail line was used, the crewmember (usually crew member 2) tending the line will keep a steady strain in an attempt to prevent the stokes litter from spinning as it rises to the helicopter.

B.18. Rescue Strop Hoist

The strop will only be used to transfer trained, uninjured military personnel in fair weather. The strop is basically a collar which has one end attached to the hoist cable. When the person to be hoisted positions the collar under the armpits, a boat crewmember must ensure the safety straps are fastened. The end of the collar opposite the hoist cable has a v-ring that attaches to the hook. [Figure 6-6](#) shows how the strop looks when properly connected. This device is not likely to hang up on attached equipment as easily as the other rescue devices.

B.19. Hoisting of Equipment

All attachment points and the equipment must be secured and monitored to keep it from catching or snagging.

B.20. Commencing Hoist

When a person or equipment is secured in the rescue device, the designated boat crewmember will give the hoist operator a “thumbs up” hand signal. The hoist operator will then commence lifting the rescue device. During this procedure, the boat crew must ensure the rescue device is not caught on anything attached to the boat.

B.21. Casting Off

When a trail line is employed, a boat crewmember shall tend it until he or she reaches the weighted end. Then the crewmember should gently release the weighted bag over the side of the boat on which the hoist was conducted (normally the port side). The bag should never be thrown upwards towards the rotors.

B.22. Post Hoist

Once the trail line is cast off, the coxswain will maneuver to starboard and away from the helicopter unless there is another hoist to be conducted

B.23. Fouled Cable/Equipment Procedure

If the cable or hoisting equipment becomes fouled it is critical that boat crew members immediately communicate this unsafe condition to the flight crew and coxswain and attempt to clear the cable or device if injury or damage is not imminent.



B.23.a.
Description

Boat crew members must be aware of all snag hazards locations on their boat prior to commencing hoisting evolutions. This also requires constant awareness and monitoring of all hoisting equipment (rescue basket, stokes litter, rescue strop, drop pump, etc.) at all times.

B.23.b.
Guidelines and Shearing

If it can be done safely, clearing fouled cables and equipment should be done quickly. All boat crewmembers should observe the following safety precautions while attempting to clear fouls. The guidelines for clearing fouled cable/equipment are as follows:

- (01) Know all snag hazards onboard your boat.
 - (02) Know proper hand signals.
 - (03) Immediately report any fouled cable/equipment to both the safety observer/coxswain (by voice) and to the hoist operator (via unsafe-condition hand signal).
 - (04) If injury or damage is not imminent, attempt to clear fouled cable or device.
 - (05) If unable to safely clear the foul, communicate the “intension to jettison device” hand signal to the flight crew, and recommend to safety observer to communicate that a shear is necessary.
 - (06) Boat Crew on-deck take cover and be aware of falling equipment when the cable is sheared.
 - (07) Coxswain recommends shear to flight crew over radio.
 - (08) Debrief fouled cable/device with flight crew via radio prior to continuing hoist evolutions.
-



**B.24. Emergency
Breakaway
Procedure**

Safety during helicopter operations cannot be overemphasized. Crewmembers must stay alert and report any danger signs. If either the coxswain or pilot feels the operation is unsafe, then a breakaway should be conducted. Procedures for the coxswain to conduct a breakaway are as follows:

Step	Procedure
1	Direct crew on deck give intention to jettison device signal.
2	Direct the crew to push the loose cable, rescue device, and trail line over the side (toward the helicopter).
3	Transmit the word “BREAKAWAY” to the pilot.
4	Turn away from the helicopter (most often to the right).
5	Energize the blue emergency light or identification light, if practical or applicable.

**B.25. Boat
Casualties During
Hoisting
(Committed)**

Boat casualties can and will occur during hoisting operations from a boat. Coxswains must anticipate their immediate actions in response to a casualty during hoist operations in order to prevent fouled or sheared cables, men going overboard, or other injuries.

**B.25.a. Engine
Casualty**

If a boat’s engine loses power while the rescue device is on deck, coxswains must maintain course and speed in order to prevent pulling the device off the boat or fouling the cable in the boat’s fixed rigging. Generally, the coxswain will have to add power on the good engine and turn toward the good engine in order to maintain course and speed. The helicopter should be notified as soon as possible.

**B.25.b. Steering
Casualty**

A steering casualty should cause the coxswain to signal an emergency breakaway. Every attempt should be made to maintain course and speed by using the engines to steer.

**B.25.c. Radio
Casualty**

A radio casualty may not require an emergency breakaway, but may require the use of an agreed upon hand signal, so that the hoist is aborted safely. If available, the boat should always have backup communication source (BCCS, second radio, hand-held radio, etc.).



Section C. Helicopter Ditching

Introduction There is always the possibility a helicopter may have to ditch in the water. Coast Guard air crews receive extensive training in escape procedures for such emergencies. However, they may be disoriented due to personal injuries, aircraft attitude, aircraft damage, and/or environmental factors. For this reason, boat crewmembers must be familiar with emergency exits and entrances. It may be necessary to open emergency exits to pull trapped air crewmembers to safety. The MH-60 has five emergency openings ([Figure 6-16](#)) and the MH-65 has four ([Figure 6-17](#)).

NOTE 

Boat Station personnel are encouraged to visit nearby Air Stations or have partner Air Station aircraft visit the Station (if feasible) to receive an emergency exit briefing from qualified air crewmembers.

In this Section

This section contains the following information:

Title	See Page
Assisting a Downed Helicopter	6-30

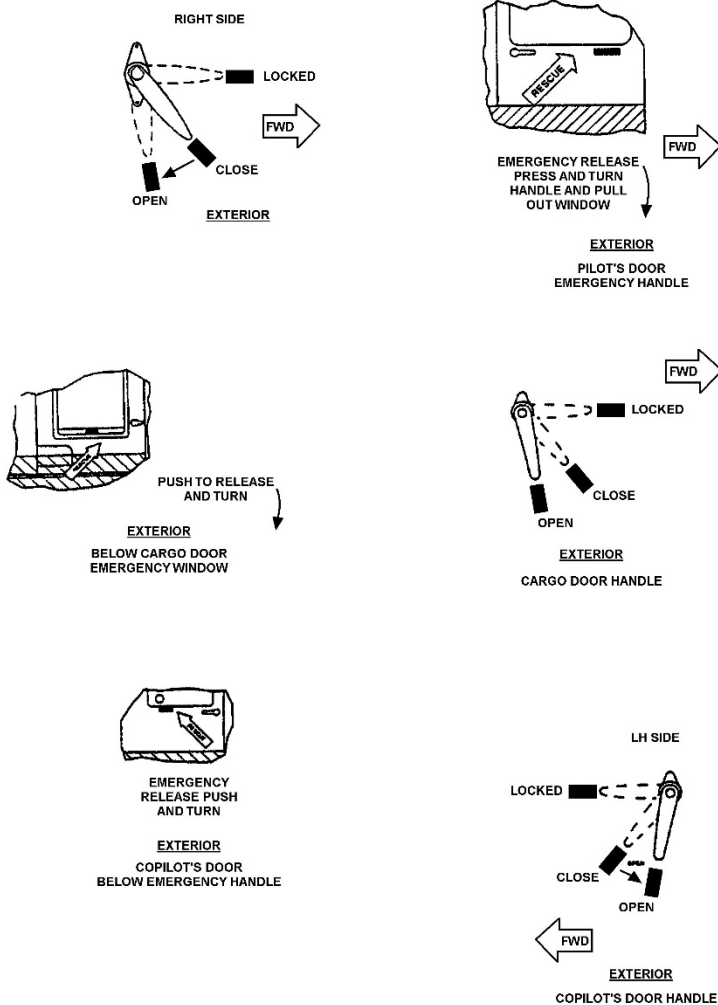
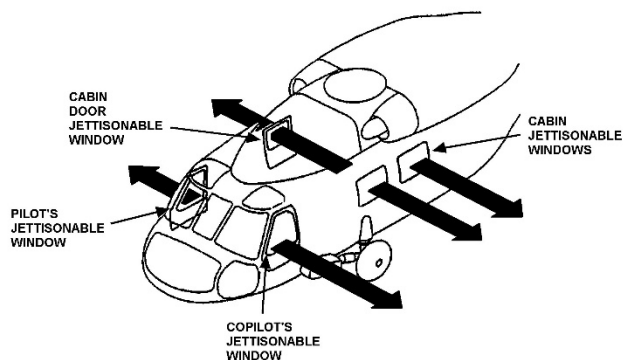

Figure 6-16
MH-60 Emergency Entrances

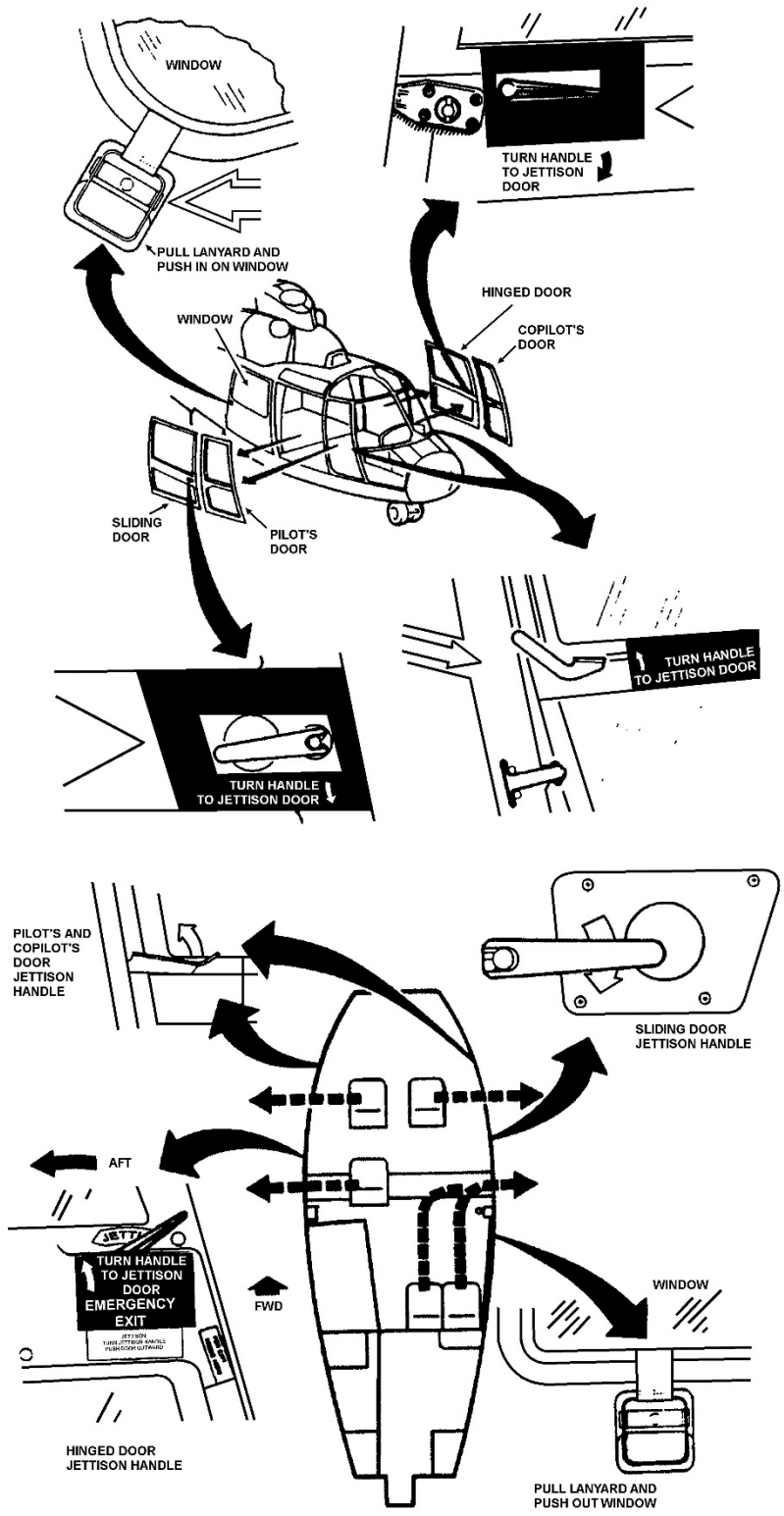

Figure 6-17
MH-65 Emergency Entrances



**C.1. Assisting a
Downed
Helicopter**

If a helicopter goes down near the boat during a hoist operation or the crew is called to assist a downed helicopter, perform the following procedures:

Step	Procedure
1	Ensure the Operational Commander is advised of the ditching.
2	Approach bow-on from the leeward side of the helicopter.
3	Make minimal wake so the vertical stability is not disrupted (when the helicopter is in an upright position).
4	Be alert to the position of the rotor blades when recovering air crew.
5	If a boat crewmember must enter the water to assist with recovery of the air crew, that crewmember must wear a boat swimmer's harness tended from the boat, if available.

CAUTION !

Boat crewmembers will not enter an inverted aircraft! Only a qualified diver may enter a helicopter after it has inverted (turned upside-down).



Section D. Fixed-Wing Aircraft

Introduction Boat operations with fixed-wing aircraft are not frequently performed. However, this type of aircraft can provide extended search of an area and increased communication range while the boat does the detailed search and the actual inspection or assistance. Coast Guard aircraft will have their distinctive painting design and carry a VHF-FM radio for contacting maritime vessels. Also, Coast Guard Auxiliary fixed-wing aircraft may be available to assist.

In this Section This section contains the following information:

Title	See Page
Auxiliary Aircraft	6-31
Communications with Aircraft	6-31

D.1. Auxiliary Aircraft

Auxiliary aircraft are commonly known as general aviation aircraft. They are mostly single-engine land planes, either high wing or low wing. There may be some twin-engine aircraft, seaplanes, or helicopters. Auxiliary aircraft have no special painting design, but all are required to have their Federal Aviation Administration registration numbers on the fuselage or tail. The Coast Guard logo and lettering are not permitted; however, the facility decal is required. The aircraft may also carry the Auxiliary logo decal aft of the wings and/or the word RESCUE on the bottom of the wing or fuselage in 12-inch letters (visible from low altitudes). From the surface, an Auxiliary aircraft looks like any other civilian airplane.

D.2. Communications with Aircraft

Communication between a boat and an aircraft can be done by voice radio or a variety of visual signals. Aircraft are equipped with VHF-AM aeronautical radios. In addition, those performing Coast Guard missions carry VHF-FM radios. The normal method for aircraft-boat contact is by means of the VHF-FM radio, calling on Channel 16 and then shifting over to a working frequency. Air-to-surface and surface-to-air visual signals may be used when a radio is not available.



D.2.a. Air-to-Surface Visual Signals

(Figure 6-18) shows air-to-surface signals that an aircraft may send to a boat. An aircraft may use the following signals to direct a boat to a place:

- (01) Circle the vessel at least once.
- (02) Cross the vessel's projected course close ahead at a low altitude while rocking the wings (opening and closing the throttle or changing the propeller pitch may be used instead of rocking the wings).
- (03) Head in the direction in which the vessel is to be directed.

An aircraft may show that assistance of the vessel is no longer required by crossing the vessel's wake close astern at low altitude while rocking the wings (opening and closing the throttle or changing the propeller pitch may be used instead of rocking the wings).

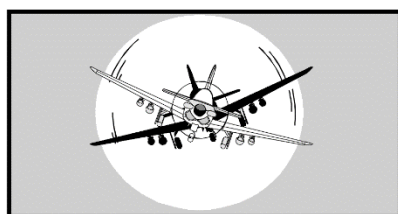

Message received and understood
(Rocking the wings)

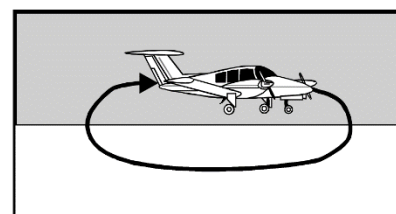

Message received and not understood
(Circling)

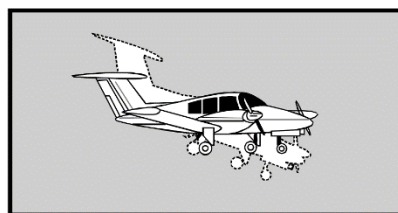

Affirmative
(Pitching nose up and down)

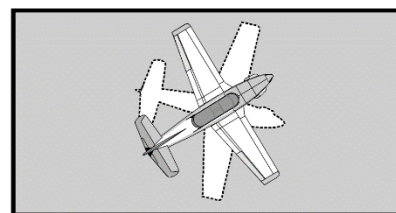

Negative
(Yawing left and right)

Figure 6-18
Air-to-Surface Visual Signals



APPENDIX A Glossary

Introduction

This appendix contains a list of terms that may be useful when reading this Handbook.

In this Appendix

This appendix contains the following information:

Topic	See Page
Glossary	A-1

TERM	DEFINITION
Abeam	To one side of a vessel, at a right angle to the fore-and-aft centerline.
Aft	Near or toward the stern.
Aground	With the keel or bottom of a vessel fast on the sea floor.
Aids to Navigation (AtoN)	Lighthouses, lights, buoys, sound signals, racon, radiobeacons, electronic aids, and other markers on land or sea established to help navigators determine position or safe course, dangers, or obstructions to navigation.
Amidships	In or towards center portion of the vessel, sometimes referred to as “midships.”
Astern	The direction toward or beyond the back of a vessel.
Attitude	A vessel’s position relative to the wind, sea, hazard, or other vessel.
Backing Plate	A reinforcement plate below a deck or behind a bulkhead used to back a deck fitting. It is usually made of wood or steel and distributes stress on a fitting over a larger area and prevents bolts from pulling through the deck.
Backing Strap (AFT Spring Line)	Line used when towing a vessel alongside which may be secured near the towing vessel’s stern and the towed vessel’s bow.
Ballast	Weight placed in a vessel to maintain its stability.
Beacon	Any fixed aid to navigation placed ashore or on marine sites. If lighted, they are referred to as minor lights.
Beam	The widest point of a vessel on a line perpendicular to the keel, the fore-and-aft centerline.
Below	The space or spaces that are underneath a vessel’s main deck.
Bilge	The lowest point of a vessel’s inner hull, which is underwater.
Bitt	A strong post of wood or metal, on deck in the bow or stern, to which anchor, mooring, or towing lines may be fastened.



TERM	DEFINITION
Boat hook	A hook on a pole with a pushing surface at the end used to retrieve or pick up objects, or for pushing objects away.
Bollard	A single strong vertical fitting, usually iron, on a deck, pier, or wharf, to which mooring lines or a hawser may be fastened.
Boom	A spar used to spread a fore-and-aft sail, especially its foot; without a sail and with a suitable lift attached; it can be used as a lifting device or derrick.
Bow	The forward end of the vessel.
Bow Line	A line secured from the bow of a vessel. In an alongside towing operation, the bow line is secured on both the towing and the towed vessel at or near the bow and may act as breast line of each.
Breakaway	Command given by coxswain, conning officer, or pilot when a helicopter hoisting operation, towing, or alongside evolution has to be terminated due to unsafe conditions.
Breaker	A wave cresting with the top breaking down over its face.
Breaking Seas	Breaking Seas, also known as “Sea Breaks,” are wind-driven waves that form crests, which tend to become unstable and topple forward, or “break,” creating a ridge of turbulence, white water, or foam.
Breaking Strength (BS)	The force needed to break or part a line. BS is measured in pounds. More specifically, it is the number of pounds of stress a line can hold before it parts.
Breast Line	Mooring or dock line extended laterally from a one vessel to a pier, float, or another vessel as distinguished from a towing or backing strap (Spring lines).
Bridle	A device attached to a vessel or aircraft (in the water) in order for another vessel to tow it. Its use can reduce the effects of yawing, stress on towed vessel fittings, and generally gives the towing vessel greater control over the tow.
Broach	To be thrown broadside to surf or heavy sea.
Broadside to the Sea	A vessel being positioned so that the sea is hitting either the starboard or port side of the vessel.
Bulkhead	Walls or partitions within a vessel with structural functions such as providing strength or watertightness. Light partitions are sometimes called partition bulkheads.
Bullnose	A round opening at the forwardmost part of the bow through which a towline, mooring line or anchor line passes.
Buoy	A floating aid to navigation anchored to the bottom that conveys information to navigators by their shape or color, by their visible or audible signals, or both.
Buoyancy	The tendency or capacity for a vessel to remain afloat.
Capsize	To turn a vessel bottom side up.



TERM	DEFINITION
Catenary	The sag in a length of chain, cable, or line because of its own weight and which provides a spring or elastic effect in towing, anchoring, or securing to a buoy.
Cavitation	The formation of a partial vacuum around the propeller blades of a vessel.
Center of Gravity	Point in a ship where the sum of all moments of weight is zero. With the ship at rest, the center of gravity and the center of buoyancy are always in a direct vertical line. For surface ships, center of buoyancy is usually below center of gravity, and the ship is prevented from capsizing by the additional displacement on the low side during a roll. Thus the point at which the deck edge enters the water is critical because from here onward, increased roll will not produce corresponding increased righting force.
Centerline	An imaginary line down the middle of a vessel from bow to stern.
Chafe	To wear away by friction.
Chafing Gear	Material used to prevent chafing or wearing of a line or other surface.
Chart	A printed or electronic geographic representation generally showing depths of water, aids to navigation, dangers, and adjacent land features useful to mariners (See <i>Nautical Chart</i>).
Chine	The intersection of the bottom and the sides of a flat bottom or “V” hull boat.
Chock	A metal fitting through which hawsers and lines are passed. May be open or closed. Blocks used to prevent aircraft or vehicles from rolling. Also, blocks used to support a boat under repair.
Chop	Short steep waves usually generated by local winds and/or tidal changes. Change of operational control. The date and time at which the responsibility for operational control of a ship or convoy passes from one operational control authority to another.
Cleat	An anvil-shaped deck fitting for securing or belaying lines. Wedge cleats are used in yachting to hold sheets ready for instant release.
Closeout	The result of a wave breaking, from the ends toward the middle, or two waves breaking toward each other; should be avoided because they can create more energy than a single break.
Closing	The act of one vessel reducing the distance between itself and another vessel, structure, or object.
Clove Hitch	A hitch often used for fastening a line to a spar, ring, stanchion, or other larger lines or cables.
Coastal	At or near a coast.
Comber	A wave at the point of breaking.
Combustion	Rapid oxidation of combustible material accompanied by a release of energy in the form of heat and light.



TERM	DEFINITION
Compartment	A room or space onboard ship. Usually lettered and numbered according to location and use.
Compass	An instrument for determining direction: magnetic, depending on the earth’s magnetic field for its force; gyroscopic, depending on the tendency of a free-spinning body to seek to align its axis with that of the earth.
Course (C)	The horizontal direction in which a vessel is steered or intended to be steered, expressed as angular distance from north, usually from 000° at north, clockwise through 360°.
Coxswain	Person in charge of a boat, pronounced “COX-un.”
Crab	To move sidewise through the water.
Craft	Any air or sea-surface vehicle, or submersible of any kind or size.
Crest	The top of a wave, breaker, or swell.
Current (Ocean)	Continuous movement of the sea, sometimes caused by prevailing winds, as well as large constant forces, such as the rotation of the earth, or the apparent rotation of the sun and moon. Example is the Gulf Stream.
Damage Control	Measures necessary to preserve and re-establish shipboard watertight integrity, stability, and maneuverability; to control list and trim; to make rapid repairs of material. Inspection of damage caused by fire, flooding, and/or collision and the subsequent control and corrective measures.
Datum	In SAR, refers to the probable location of a distressed vessel, downed aircraft, or PIW, which is corrected for drift at any moment in time. Depending on the information received this may be represented as a point, a line or an area.
Dewatering	The act of removing water from inside compartments of a vessel. Water located high in the vessel, or sufficiently off-center should be removed first to restore the vessel’s stability. Used to prevent sinking, capsizing or listing.
Dead-in-the-Water (DIW)	A vessel that has no means to maneuver, normally due to engine casualty. A vessel that is adrift or no means of propulsion.
Deadman’s Stick	See <i>static discharge wand</i> .
Deck	The horizontal plating or planking on a ship or boat.
Deck Fitting	Permanently installed fittings on the deck of a vessel which can be attached to machinery or equipment.
Distress	As used in the Coast Guard, when a craft or person is threatened by grave or imminent danger requiring immediate assistance.
Ditching	The forced landing of an aircraft on water.



TERM	DEFINITION
Dolphin	A structure consisting of a number of piles driven into the seabed or river bed in a circular pattern and drawn together with wire rope. May be used as part of a dock structure or a minor aid to navigation. Commonly used when a single pile would not provide the desired strength.
Draft	The point on a vessel’s underwater body, measured from the waterline, that reaches the greatest depth.
Drag	Forces opposing direction of motion due to friction, profile and other components. The amount that a ship is down by the stern.
Drift	The rate/speed at which a vessel moves due to the effects of wind, wave, current, or the accumulative effects of each. Usually expressed in knots.
Drogue	A device used to slow rate of movement. Commonly rigged off the stern of a boat while under tow to reduce the effects of following seas. May prevent yawing and/or broaching. (see <i>sea anchor</i>)
Drop Pump	A portable, gasoline-powered pump that is transported in a water tight container. Used for de-watering a vessel.
Dynamic Forces	Forces associated with the changing environment, e.g., the wind, current, weather.
Ebb	A tidal effect caused by the loss of water in a river, bay, or estuary resulting in discharge currents immediately followed by a low tidal condition.
Ebb Current	The horizontal motion away from the land caused by a falling tide.
Eddy	A circular current.
Eductor	A siphon device that contains no moving parts. It moves water from one place to another by forcing the pumped liquid into a rapidly flowing stream. This is known as the venturi effect. Dewatering equipment used to remove fire fighting and flooding water from a compartment in a vessel.
Eye	The permanently fixed loop at the end of a line.
Eye Splice	The splice needed to make a permanently fixed loop at the end of a line.
Fairlead	A point, usually a specialized fitting, such as a block, chock, or roller used to change the direction and increase effectiveness of a line or cable. It will, in most cases, reduce the effects of chafing.
Fairways (Mid-Channel)	A channel that is marked by safemarks that indicate that the water is safe to travel around either side of the red and white vertically striped buoy.
Fake	To lay out a line in long, flat bights that will pay out freely without bights or kinks. A coiled or fleished line cannot do this unless the coil of the line is able to turn, as on a reel. Otherwise, a twist results in the line which will produce a kink or jam.



TERM	DEFINITION
Fatigue	Physical or mental weariness due to exertion. Exhausting effort or activity. Weakness in material, such as metal or wood, resulting from prolonged stress.
Fender	A device of canvas, wood, line, cork, rubber, wicker, or plastic slung over the side of a boat/ship in position to absorb the shock of contact between vessels or between a vessel and pier.
Ferry	To transport a boat, people or goods across a body of water.
Fetch	The unobstructed distance over which the wind blows across the surface of the water.
Fitting	Generic term for any part or piece of machinery or installed equipment.
Fix	A geographical position determined by visual reference to the surface, referencing to one or more radio navigation aids, celestial plotting, or other navigation device.
Flood	A tidal effect caused by the rise in water level in a river, bay, or estuary immediately followed by a high tidal condition.
Flood Current	The horizontal motion of water toward the land caused by a rising tide.
Forward	Towards the bow of a vessel.
Foul	To entangle, confuse, or obstruct. Jammed or entangled; not clear for running. Covered with barnacles, as foul bottom.
Freeboard	Distance from the weather deck to the waterline on a vessel.
Gap Winds	Strong winds channeled through gaps in the Pacific coastal ranges, blowing out into the Pacific Ocean or into the waterways of the Inside Passage.
Global Positioning System (GPS)	A satellite-based radio navigation system that provides precise, continuous, worldwide, all-weather three-dimensional navigation for land, sea and air applications.
Gunwale	The upper edge of a boat's side. Pronounced "gun-ul."
Half Hitch	A hitch used for securing a line to a post; usually seen as two half hitches.
Harbor	Anchorage and protection for ships. A shelter or refuge.
Head Up (Heads Up)	A warning given before throwing a messenger, heaving, or towline to alert people to be ready for receipt of line and to avoid being hit by the object being thrown. Potential danger warning.
Heading	The direction in which a ship or aircraft is pointed.
Heaving Line	Light, weighted line thrown across to a ship or pier when coming along side to act as a messenger for a mooring line. The weight is called a monkey fist.



TERM	DEFINITION
Heel	Temporary leaning of a vessel to port or starboard caused by the wind and sea or by a high speed turn.
Helm	The apparatus by which a vessel is steered; usually a wheel or tiller.
Hoisting Cable	The cable used to perform a boat/helo hoisting evolution.
Hull	The body or shell of a ship or seaplane.
Hypothermia	A lowering of the core body temperature due to exposure of cold (water or air) resulting in a subnormal body temperature that can be dangerous or fatal. The word literally means “underheated.”
In Step (Position)	The towing boat keeping the proper position with the towed boat. For example; the proper distance in relation to sea/swell patterns so that both boats ride over the seas in the same relative position wave crest to wave crest.
Inboard/Outdrive (I/O)	An inboard engine attached through the transom to the outdrive.
Inlet	A recess, as a bay or cove, along a coastline. A stream or bay leading inland, as from the ocean. A narrow passage of water, as between two islands.
Interference	The simultaneous presence of two or more waves in the same position, resulting in a new wave pattern.
Keel	The central, longitudinal beam or timber of a ship from which the frames and hull plating rise.
Knockdown	When a boat has rolled in one direction 90 degrees or greater but does not completely rollover (360) to right itself. (Example: Boat rolls to port 120 degrees and rights itself by rolling back to starboard.)
Knot (kn or kt)	A unit of speed equivalent to one nautical mile (6,080 feet) per hour. A measurement of a ship’s speed through water. A collective term for hitches and bends.
Leeward	The side or direction away from the wind, the lee side.
Leeway	The drift of an object with the wind, on the surface of the sea. The sideward motion of a ship because of wind and current, the difference between her heading (course steered) and her track (course made good). Sometimes called drift. In SAR, movement of search object through water caused by local winds blowing against that object.
Life Jacket	<i>See personal flotation device.</i>
Life Ring (Ring Buoy)	A buoyant device, usually fitted with a light and smoke marker, for throwing to a person in the water.



TERM	DEFINITION
Lifeline	Line secured along the deck to lay hold of in heavy weather; any line used to assist personnel; knotted line secured to the span of lifeboat davits (manropes or monkey lines) for the use of the crew when hoisting and lowering. The lines between stanchions along the outboard edges of a ship's weather decks are all loosely referred to as lifelines, but specifically the top line is the lifeline, middle is the housing line, and bottom is the footline. Any line attached to a lifeboat or life raft to assist people in the water. Also called a grab rope.
List	The static, fixed inclination or leaning of a ship to port or starboard due to an unbalance of weight.
Longshore Current	A currents that runs parallel to the shore and inside the breakers as a result of the water transported to the beach by the waves.
Lookout	A person stationed as a visual watch.
Loudhailer	A loudspeaker; public address system.
Maritime	Located on or close to the sea; of or concerned with shipping or navigation.
Mast	A spar located above the keel and rising above the main deck to which may be attached sails, navigation lights, and/or various electronic hardware. The mast will vary in height depending on vessel type or use.
Mayday	The spoken international distress signal, repeated three times. Derived from the French <i>M'aider</i> (help me).
Mooring	A chain or synthetic line that attaches a floating object to a stationary object, e.g. dock, sinker.
Motor Lifeboat (MLB)	Coast Guard boat designed to perform SAR missions, including surf and bar operations, in adverse weather and sea conditions. They are self-righting and self-bailing.
N-dura Hose	Double-synthetic jacketed and impregnated rubber-lined hose, orange in color, used in the Coast Guard for fire fighting.
Navigable Channel	A channel that has sufficient depth to be safely navigated by a vessel.
Navigable Waters	Coastal waters, including bays, sounds, rivers, and lakes, that are navigable from the sea.
Navigation	The art and science of locating the position and plotting the course of a ship or aircraft.
Night Sun	A helicopter's light that is an effective search tool at night in a clear atmosphere with no moisture in the air.
Offshore	The region seaward of a specified depth. Opposite is inshore or near-shore.
On Scene	The search area or the actual distress site.
Opening	The increasing of distance between two vessels.



TERM	DEFINITION
Out of Step	The position of two boats (i.e., towing operations) where one boat is on the top of the crest of a wave and the other is in the trough between the waves.
Outboard	In the direction away from the center line of the ship. Opposite is inboard. Also, an engine which is attached to the transom of a vessel.
Outdrive	A transmission and propeller or jet drive attached to the transom of a vessel.
Overhauling the Fire	The general procedures performed after a fire has been extinguished. They include breaking up combustible material with a fire axe or a fire rake, and cooling the fire area with water or fog.
Overload	Exceeding the designed load limits of a vessel; exceeding the recommended work load of line or wire rope.
Pad-Eye	A metal ring welded to the deck or bulkhead.
Persons Onboard (POB)	The number of people aboard a craft.
Personal Flotation Device (PFD)	A general name for various types of devices designed to keep a person afloat in water, e.g., life preserver, vest, cushion, ring, and other throwable items.
Piling	A long, heavy timber driven into the seabed or river bed to serve as a support for an aid to navigation or dock.
Pitch	The vertical motion of a ship's bow or stern in a seaway about the athwartships axis. Of a propeller, the axial advance during one revolution. (See <i>roll</i> , <i>yaw</i> .)
Pitchpole	A vessel going end-over-end, caused by large waves or heavy surf. The bow buries itself in the wave and the stern pitches over the bow, capsizing the vessel.
Planing Hull	A boat design that allows the vessel to ride with the majority of its hull out of the water once its cruising speed is reached, e.g., 8-meter RHI.
Port	The left side of the vessel looking forward toward the bow.
Propeller	A device consisting of a central hub with radiating blades forming a helical pattern and when turned in the water, creates a discharge that drives a boat.
Pyrotechnics	Ammunition, flares, or fireworks used for signalling, illuminating, or marking targets.
Quarter	One side or the other of the stern of a ship. To be broad on the quarter means to be 45° away from dead astern; starboard or port quarter is used to indicate a specific side.
RACON	See <i>radar beacon</i> .
Radar	Radio detecting and ranging. An electronic system designed to transmit radio signals and receive reflected images of those signals from a "target" in order to determine the bearing and distance to the "target."



TERM	DEFINITION
Radio Watch	The person assigned to stand by and monitor the radios. Responsible for routine communication and logging, as well as properly handling responses to emergency radio communications.
Range	A measurement of distance usually given in yards. Also, a line formed by the extension of a line connecting two charted points.
Re-Flash Watch	A watch established to prevent a possible re-flash or rekindle of a fire after a fire has been put out.
Rescue Basket	A device for lifting an injured or exhausted person out of the water.
Rescue Swimmer	A specially trained individual that is deployed from a helicopters, boats, or cutters to recover an incapacitated victim from the water, day or night.
Rig	To devise, set up, arrange. An arrangement or contrivance. General description of a ship's upper works; to set up spars or to fit out. A distinctive arrangement of sails (rigging), as in a schooner rig. An arrangement of equipment and machinery, as an oil rig.
Rigging	The ropes, lines, wires, turnbuckles, and other gear supporting and attached to stacks, masts and topside structures. Standing rigging more or less permanently fixed. Running rigging is adjustable, (e.g., cargo handling gear).
Rip Current	A current created along a long beach or reef surf zone due to water from waves hitting the beach and traveling out to the sides and parallel to the shore line, creating a longshore current that eventually returns to sea.
Roll	Vessel motion caused by a wave lifting up one side of the vessel, rolling under the vessel and dropping that side, then lifting the other side and dropping it in turn.
Rollover	When a boat rolls in one direction and rights itself by completing a 360 degree revolution.
Rough Bar	Rough bar is determined to exist when breaking seas exceed 8 feet and/or when, in the judgment of the CO/OIC, rough bar/surf conditions exist, and/or whenever there is doubt in the judgment of the coxswain as to the present conditions.
Rudder	A flat surface rigged vertically astern used to steer a ship, boat, or aircraft.
Sail Area	On a vessel, the amount of surface upon which the wind acts.
Sampson Post	Vertical timber or metal post on the forward deck of a boat used in towing and securing. Sometimes used as synonym for king post.
Scope	The length of anchor line or chain. Number of fathoms of chain out to anchor or mooring buoy. If to anchor, scope is increased in strong winds for more holding power. Also, the length of towline or distance from the stern of the towing vessel to the bow of the tow.
Screw	A vessel's propeller.
Scuttle	A small, quick-closing access hole; to sink a ship deliberately.



TERM	DEFINITION
Sea Breaks	See breaking seas.
Sea Current	Movement of water in the open sea.
Sea Drogue	See <i>sea anchor</i> .
Search Pattern	A track line or procedure assigned to an SRU for searching a specified area.
Seaward	Toward the main body of water, ocean. On the Intracoastal Waterway, returning from seaward is from north to south on the eastern U.S. coast, east to west across the Gulf of Mexico, and south to north along the western seacoast.
Set (of a Current)	The direction toward which the water is flowing. A ship is set by the current. A southerly current and a north wind are going in the same direction. Measured in degrees (usually true).
Shackle	A U-shaped metal fitting, closed at the open end with a pin, used to connect wire, chain, or line.
Ship	Any vessel of considerable size navigating deepwater, especially one powered by engines and larger than a boat. Also, to set up, to secure in place. To take something aboard.
Shoaling	is an increase in wave amplitude that happens when waves go from deep to shallow water , the energy of the waves remains the same, thus the wavelength becomes shorter which results in increased wave heights.
Shock Load	Resistance forces caused by intermittent and varying forces of waves or sea conditions encounter by a towing boat on its towing lines and equipment.
Skeg	The continuation of the keel aft under the propeller; in some cases, supports the rudder post.
Skiff Hook (Kicker Hook)	A ladder hook or a stainless steel safety hook to which a six inch length of stainless steel round stock has been welded. A hook that is used in attaching a tow line to a small trailerable boat, using the trailer eyebolt on the boat.
Sling	A type of rescue device used by a helicopter to hoist uninjured personnel; a lifting device for hoisting cargo.
Slip Clove Hitch	A hitch used when it may be necessary to quickly release a piece of equipment, e.g., fenders or fender board.
Small Stuff	Any line up to 1.5" in circumference.
Sound Signal	A device that transmits sound, intended to provide information to mariners during periods of restricted visibility and foul weather; a signal used to communicate a maneuver between vessels in sight of each other.
Spring Line	A mooring line that makes an acute angle with the ship and the pier to which moored, as opposed to a breast line, which is perpendicular, or nearly so, to the pier face; a line used in towing alongside that enables the towing vessel to move the tow forward and/or back the tow, e.g., tow spring and backing spring.



TERM	DEFINITION
Stanchion	A vertical metal or wood post aboard a vessel.
Starboard	The right side of the vessel looking forward toward the bow.
Static Discharge Wand	A pole-like device used to discharge the static electricity during helicopter hoisting/rescue operations. Also known as a deadman's stick.
Static Electricity	A quantity of electricity that builds up in an object and does not discharge until provided a path of flow.
Station Keeping	The art of keeping a boat in position, relative to another boat, aid, or object with regard to current, sea, and/or weather conditions.
Steerage	The act or practice of steering. A ship's steering mechanism.
Steerageway	The lowest speed at which a vessel can be steered.
Stem	The principal timber at the bow of a wooden ship, to which the bow planks are rabbeted. Its lower end is scarfed to the keel, and the bowsprit rests on the upper end. The cutwater, or false stem (analogous to false keel), is attached to the fore part of the stem and may be carved or otherwise embellished, especially in the vicinity of the head, which usually rests upon it. In steel ships, the stem is the foremost vertical or near-vertical strength member, around which or to which the plating of the bow is welded or riveted. Compare stern-post.
Stem Pad-Eye (Trailer Eye Bolt)	An attaching point available on most trailerized boats.
Stern	The extreme after end of a vessel.
Stokes Litter	A rescue device generally used to transport non-ambulatory persons or persons who have injuries that might be aggravated by other means of transportation.
Strobe Light	A device that emits a high intensity flashing light visible for great distances. Used to attract the attention of aircraft, ships, or ground parties, it flashes white light at 50 plus or minus 10 times per minute.
Superstructure	Any raised portion of a vessel's hull above a continuous deck, e.g., pilot house.
Surf	Several waves or swells of the sea breaking on the shore, shoal, reef, bar, or inlet.
Surf Line	The outermost line of waves that break near shore, over a reef, or shoal. Generally refers to the outermost line of consistent surf.
Surf Zone	The area where surf exists, between the outermost and innermost breaking waves.
Swell	Wind-generated waves which have advanced into a calmer area and are decreased in height and gaining a more rounded form. The heave of the sea. See <i>roller</i> .
Swimmer's Harness	A harness used to tether and retrieve surface swimmers during rescue/recovery operations.



TERM	DEFINITION
Tactical Diameter	The distance made to the right or left of the original course when a turn of 180° has been completed with the rudder at a constant angle.
Thimble	A metal ring grooved to fit inside a grommet or eye splice.
Through Bolt	A bolt that is used to fasten a fitting to the deck. It goes through the deck and backing plate (located below deck).
Thumbs Up	A signal given by the designated crewmember to indicate hoisting operation is to begin.
Tidal Current	The horizontal motion of water caused by the vertical rise and fall of the tide.
Tide	The periodic vertical rise and fall of the water resulting from the gravitational interactions between the sun, moon, and earth.
Topside	The area above the main deck on a vessel; weather deck.
Tow Line	A line, cable, or chain used in towing a vessel.
Tow Strap	When towing alongside, the tow strap is secured near the towing vessel's bow and the towed vessel's stern (see <i>spring line</i>).
Towing Watch	A crewmember who monitors the safety of a towing operation. Responsible to the coxswain.
Trail Line	A weighted line that is lowered from a helo before the rescue device. Its purpose is to allow the personnel below to guide and control the rescue device as it is lowered.
Trim	The fore-and-aft inclination of a ship, down by the head or down by the stern. Sometimes used to include list. Also means shipshape, neat.
Tripping Line	Small line attached to the small end of a drogue, so the device can be turned around to be retrieved.
Trough	The valley between waves.
Vari-Nozzle	A fire-fighting nozzle having a fully adjustable spray head that allows the operator to deliver a wide range of spray patterns (from stream to low velocity fog).
Vessel	By U.S. statutes, includes every description of craft, ship or other contrivance used as a means of transportation on water. "Any vehicle in which man or goods are carried on water." (see <i>ship</i>)
Wake	The disturbed water astern of a moving vessel.
Wave	A periodic disturbance of the sea surface, caused by wind (and sometimes by earthquakes).
Wave Height	The height from the bottom of a wave's trough to the top of its crest; measured in the vertical, not diagonal.



TERM	DEFINITION
Wave Interference	Caused by waves, refracted or reflected, interacting with other waves, often increasing or decreasing wave height.
Wave Length	The distance from one wave crest to the next in the same wave group or series.
Wave Period	The time, in seconds, it takes for two successive crests to pass a fixed point.
Wave Reflection	The tendency of a wave to move back towards the incoming waves in response to interaction with any obstacle.
Wave Refraction	The tendency of a wave to bend in response to interaction with the bottom and slows in shoal areas. Refraction also occurs when a wave passes around a point of land, jetty, or an island.
Wave Saddle	The lowest part of a wave, bordered on both sides by higher ones; often small, unbroken section of a wave that is breaking.
Wave Shoulder	The edge of a wave. It may be the very edge of the whitewater on a breaker, or the edge of a high peaking wave that is about to break.
Wedge	Used as temporary repair in event of damage aboard vessel. Made of soft wood, they are forced into holes or damaged areas to stop leaking, to plug damaged structures, or to reinforce shoving. Part of a damage control kit.
White Water	<i>See foam crest.</i>
Williamson Turn	Used if an individual or object falls overboard during periods of darkness or restricted visibility and the exact time of the incident is unknown. Done by turning 60° to port or starboard from the original course, there shifting rubber until vessel comes about on a reverse course. May be of little value to boats having a small turning radius.
Wind Direction	The true heading from which the wind blows.
Wind-Driven Current	The effect of wind pushing water in the direction of the wind.
Window	An area where the waves have momentarily stopped breaking, opening up a safer area of operation for a vessel.
Windward	Towards the wind.
Working Turn	A working turn is a towline placed on a bitt that allows enough surface contact to ensure positive control of the towline. A working turn begins with a round turn placed on the bitt, and depending on the factors of the object being towed (e.g. size, weight, wind and seas) may require additional figure eights to effectively maintain control.
Yaw	Rotary oscillation about a ship's vertical axis in a seaway. Sheering off alternately to port and starboard.



APPENDIX B List of Acronyms

Introduction

This appendix contains a list of acronyms that may be useful when reading this and other Boat Crew Handbooks.

In this Appendix

This appendix contains the following information:

Topic	See Page
List of Acronyms	B-2



ACRONYM	DEFINITION
A/C	Air Conditioning
AAR	After Action Report
ACFT	Aircraft
ACIP	Aviation Incentive Pay
ACMS	Aviation Computerized Maintenance System
ACP	Area Contingency Plan
ACP	Alternate Compliance Program
ACTSUS	Active Suspension
ADF	Automatic Radio Direction Finder
ADSW-AC	Active Duty Special Work in Support of Active Component
ADT	Active Duty for Training
ADT-AT	Active Duty Training for Annual Training
AEO	Assistant Engineering Officer
AEPO	Assistant Engineering Petty Officer
AFC	Allowance Fund Control
AFFF	Aqueous Film – Forming Foam
AIDS	Acquired Immunodeficiency Syndrome
AIM	Administrative Investigations Manual
AIS	Automatic Identification System
AH	Amplitude Modulation
AMIO	Alien/Migrant Interdiction Operation
AMS	Automated Manifest System
AMVER	Automated Mutual-Assistance Vessel Rescue
ANB	Aids to Navigation Boat
ANS	Aquatic Nuisance Species
ANSI	American National Standards Institute
ANT	Aids to Navigation Team
AOPS	Abstract of Operations
AOR	Area of Responsibility
API	American Petroleum Institute
APPS	Act to Prevent Pollution from Ships
APR	Aid Positioning Report



ACRONYM	DEFINITION
ASB	Arctic Survey Boat
ATB	Aviation Training Boat
AtoN	Aids to Navigation
AtoNIS	Aids to Navigation Information System
ATR	Ammunition Transaction Report
AUXCOM	Auxiliary Boat Commander
AUX DATA	Auxiliary Data
AUXPATCOM	Auxiliary Patrol Commander
AV	Aid Verifier
BA	Bridge Administration
BAC	Blood Alcohol Content
BAS	Basic Allowance for Subsistence
BCEB	Boat Crew Examination Boards
BCM	Boat Crewmember
BCMP	Boat Class Maintenance Plan
BDCM	Buoy Deck Crewmember
BDS	Buoy Deck Supervisor
BECCE	Basic Engineering Casualty Control Exercises
BEQ	Bachelor Enlisted Quarters
BM	Boatswain's Mate
BNTM	Broadcast Notice to Mariners
BO	Boarding Officer
BO/BTM PQS	Boarding Officer / Boarding Team Member Personnel Qualification Standard
BOSN	Boatswain
BS	Breaking Strength
BSC	Boating Safety Circular
BTM	Boarding Team Member
BUSL	Buoy Utility Stern Loading
BWI	Boating While Intoxicated
BWM	Ballast Water Management
C2	Command and Control
C2PC	Command/Control Personal Computer
CABs	Compressions, Airway, and Breathing



ACRONYM	DEFINITION
CAC	Crisis Action Center
CASCOR	Casualty Correct
CASREP	Casualty Report
CBL	Commercial Bill of Lading
CB-L	Cutter Boat – Large
CB-M	Cutter Boat – Medium
CB-OTH	Cutter Boat – Over the Horizon
CBRN	Chemical, Biological, Radiological, Nuclear
CB-S	Cutter Boat – Small
CDAR	Collateral Duty Addictions Representative
CDI	Course Deviation Indicator
CDO	Command Duty Officer
CDR	Commander
CDV	Course Deviation Variance
CEM	Crew Endurance Management
CERCLA	Comprehensive Environment Compensation and Liability Act
CEU	Civil Engineering Unit
CF	Comparison Factors
CFC	Combined Federal Campaign
CFR	Code of Federal Regulations
CFVS	Commercial Fishing Vessel Safety
CGADD	Coast Guard Addendum
CGDF	Coast Guard Dining Facility
CGIS	Coast Guard Investigative Service
CGPC	Coast Guard Personnel Command
CIC	Combat Information Center
CIO	Command Intelligence Officer
CISM	Critical Incident Stress Management
CM	Configuration Management
CMAA	Chief Master at Arms
CMCO	Classified Material Control Officer
CMG	Course Made Good
CMS	COMSEC (Communication Security) Material System



ACRONYM	DEFINITION
CO	Commanding Officer or Carbon Monoxide
CO/OIC	Commanding Officer/Officer-in-Charge
COCO	Chief of Contracting Officer
COFR	Certificate of Financial Responsibility
COG	Course Over Ground
COI	Certificate of Inspection
COLREG	International Regulations for Preventing Collisions at Sea
COMCEN	Communications Center
COMDTINST	Commandant Instruction
COMINT	Communications Intelligence
COMMS	Communications
CONOPS	Concept of Operations
COR	Certificate of Registry
COTP	Captain-of-the-Port
COTR	Contracting Officer's Technical Representative
CPC	Commandant's Performance Challenge
CPO	Chief Petty Officer
CPR	Cardiopulmonary Resuscitation
CPU	Central Processing Unit
CQA	Commandant's Quality Award
CRT	Cathode Ray Tube
CS	Creeping Line Search
CSIM	Control Station Interface Module
CSMP	Current Ship's Maintenance Project
CSP	Commence Search Point
CSP	Career Sea Pay
CVE	Control Verification Examination
CVS	Commercial Vessel Safety
CWO	Chief Warrant Officer
DAMA	Demand Assigned Multiple Access
DAN	Driver's Alert Network
DANTES	Defense Activity for Non-Traditional Education Support
DAPA	Drug and Alcohol Program Administration



ACRONYM	DEFINITION
DDEC	Detroit Diesel Electronically Controlled
DEER	Defense Enrollment and Eligibility Reporting System
DEMPs	Diesel Engine Maintenance Programs
DF	Direction Finding
DGPS	Differential Global Positioning System
DICP	Drop-In Communications Package
DISREP	Discrepancy Report
DISREPS	Discrepancy Report
DIW	Dead-in-the-Water
DMA	Defense Mapping Agency
DMB	Data Marker Buoy
DMOA	Designated Medical Officer Advisor
DMS	Docket Management System
DO	Defense Operations
DoD	Department of Defense
DONCAF	Department of the Navy Central Adjudication Facility
DOT	Department of Transportation
DPB	Deployable Pursuit Boat
DR	Dead Reckoning
DSC	Digital Selective Calling
DVL	Digital Voice Logger
DWO	Deck Watch Officer
DWONR	Deck Watch Officer Navigation Rules
EAP	Employee Assistance Program
EAPC	Employee Assistance Program Coordinator
EBL	Electronic Bearing Line
EC	Electronic Control
EC	Engineering Change
ECM	Electronic Control Module
ECR	Engineering Change Request
ECS	Electronic Chart System
EDF	Enlisted Drug Facilities
EDM	Electronic Display Module



ACRONYM	DEFINITION
EEZ	Exclusive Economic Zone
EGIM	Electronic Gear Interface Module
ELC	Engineering Logistics Center
ELINT	Electronics Intelligence
ELT	Emergency Locator Transmitter
ELT	Enforcement of Laws and Treaties
EMI	Extra Military Instruction
EMS	Emergency Medical Services
EMT	Emergency Medical Technician
EO	Engineering Officer
EOCT	End-of-Course Test
EP	Estimated Position
EPA	Environmental Protection Agency
EPES	Enlisted Personnel Evaluation System
EPIRB	Emergency Position Indicating Radio Beacon
EPO	Engineering Petty Officer
EPO/EO	Engineering Petty Officer/Engineering Officer
EPS	Environmental Protection Specialist
ERIM	Engine Room Interface Module
ESA	Endangered Species Act
ESD	Electronics Support Detachment
ESU/D	Electronics Support Unit/detachment
ET	Electronics Technician
ETA	Electronic Transportation Acquisition
ETA	Estimated Time of Arrival
EXCOM	Extended Communications
FAA	Federal Aviation Agency
FAR	Family Advocacy Representative
FAR	Federal Acquisition Regulations
FAST	Facial Drooping, Arm Weakness, Speech Difficulty, and Time is Critical
FBIS	Foreign Broadcast Information Service
FEDEX	Federal Express
FEEF	Federal Energy Efficiency Funding



ACRONYM	DEFINITION
FFCS	Full Function Crew Station
FID	Field Information Document
FINCEN	Finance Center
FIR	Field Intelligence Report
FL	Fitness Leader
FLOCS	Fast Lubricating Oil Change System
FLS	Fleet Logistics Supply
FM	Frequency Modulation
FMP	Fisheries Management Plan
FOIA	Freedom of Information Act
FOSC	Federal On-Scene Coordinator
FOUO	For Official Use Only
FPCON	Force Protection Conditions
FPM	Feet Per Minute
FRP	Fiberglass Reinforced Plastic
FS	Food Service Specialist
FSC	Federal Supply Classification
FSI	Field Sobriety Test
FSIC	Fiscal, Sanitation, Immigration or Customs
FSO	Food Services Officer
FWPCA	Federal Water Pollution Control Act
FWS	Fish and Wildlife Service
GAR	Green-Amber-Red
GFM	Global Freight Management
GMDSS	Global Maritime Distress and Safety System
G-OCS	Office of Boat Forces
G-OI	Office of Intelligence
GPH	Gallons Per Hour
GPS	Global Positioning System
GRUCOM	Group Commander
GSA	Government Service Administration
GTA	Government Transportation Account
GV	Government Vehicle



ACRONYM	DEFINITION
HAZCOM	Hazardous Communication
HAZMAT	Hazardous Material
HAZWASTE	Hazardous Waste
HCPV/HIV	High Capacity Passenger Vessel/High Interest Vessel
HDOP	Horizontal Dilution of Precision
HEA	Harbor Entrance and Approach
HELP	Heat Escape Lessening Position
HF	High Frequency
HIN	Hull Identification Number
HIV	Human Immunodeficiency Virus
HS	Homeland Security
HPU	Hydraulic Power Unit
HRSIC	Human Resources Services and Information Center
HSC	Harbor Safety Committee
HUMINT	Human Intelligence
HVAC	Heating, Ventilation, and Air Conditioning
IACS	International Association of Classification Societies
IALA	International Association of Lighthouse Authorities
IAMSAR	International Aeronautical and Maritime Search and Rescue
I-AtoNIS	Integrated Aids to Navigation Information Systems
ICA	Individual Credit Accounts
ICAO	International Civil Aviation Organization
ICC	Intelligence Coordination Center
ICLL	International Convention on Load Lines
ICMTS	Interagency Committee of the Marine Transportation System
ICS	Incident Command System
ICV	Intercommunicating Fill Valve
ICW	Intracoastal Waterway
IDT	Inactive Duty for Training
IEC	International Electrotechnical Commission
IIP	International Ice Patrol
IIR	Intelligence Information Report
IIRAIRA	Illegal Immigration Reform and Immigrant Responsibility Act



ACRONYM	DEFINITION
ILO	International Labor Organization
IMARV	Independent Maritime Response Vessel
IMO	International Maritime Organization
IMPAC	International Merchant Purchase Authorization Card
INA	Immigration and Nationality Act
INS	Immigration and Naturalization Service
IPIECA	International Petroleum Industry Environmental Conservation Association
IPS	International Pipe Standard
IRIS	Incident Reporting Information System
ISC	Integrated Support Command
ISM	International Ship Management
ISO	International Standards Organization
IT	Information Systems Technician
IUU	Illegal, Unreported, and Unregulated
JOOD	Junior Officer of the Day
JQR	Job Qualification Requirement
KO	Contracting Officer
LC	Load Center
LCD	Liquid Crystal Display
LCVP	Landing Craft, Vehicle, Personnel
LE	Law Enforcement
LEISII	Law Enforcement Information System II
LEMAN	Law Enforcement Manual
LEO	Law Enforcement Officer
LEQB	Law Enforcement Qualification Board
LEU	Law Enforcement Unit
LHA	Local Housing Authority
LHI	Local Housing Inspector
LIR	Letter Incident Report
LKP	Last Known Position
LLNR	<i>Light List</i> Number
LMR	Living Marine Resource
LNB	Large Navigation Buoy



ACRONYM	DEFINITION
LNG	Liquid Natural Gas
LOA	Length Overall
LOB	Line-of-Bearing
LOC	Letter of Commendation or Level of Consciousness
LOGREQ	Logistics Requirements
LOP	Line of Position
LORAN-C	Long-Range Aid to Navigation
LORSTA	LORAN Station
LOS	Line-of-Sight
LUFS	Large Unit Financial System
LUT	Local User Terminal
LWL	Length on Waterline
MAA	Master at Arms
MARB	Maritime Assistance Request Broadcast
MARPOL	International Convention for the Prevention of Pollution from Ships
MARSEC	Marine Security Conditions
MASINT	Measurement and Signature Intelligence
MAW	Maximum Allowable Weight
MBR INT	Member's Initials
MCB	Motor Cargo Boat
MCM	Manual for Courts-Martial
MCS	Master Control Station
MDA	Maritime Domain Awareness
MDV	Marine Dealer Visit
MDZ	Maritime Defense Zone
MEDICO	Medical Advice
MEDEVAC	Medical Evacuation
MEP	Marine Environmental Protection
MEPC	Marine Environment Protection Committee
MER	Marine Environmental Response
MF	Medium Frequency
MFPU	Maritime Force Protection Unit
MHS	Maritime Homeland Security



ACRONYM	DEFINITION
MI	Marine Information
MI	Maintenance Inspection
MI & R	Maintenance, Improvement and Repair
MIC	Manufacturer Identification Code
MICA	Management Information for Configuration and Allowances
MICA	Machinery Information Catalog Allowance
MIM	Marine Interface Module
MISLE	Marine Information for Safety and Law Enforcement
MJM	Military Justice Manual
MLB	Motor Lifeboat
MLC	Maintenance and Logistics Command
MLCPAC	Maintenance and Logistics Command Pacific
MMD	Merchant Mariner Document
MMPA	Marine Mammal Protection Act
MMS	Minerals Management Services
MMSI	Maritime Mobile Service Identity
MOA	Memorandum of Agreement
MOB	Man Overboard
MOU	Memorandum of Understanding
MPR	Multiple Persons-in-the-Water
MPS	Marine Protected Species
MRE	Military Rule of Evidence
MRR	Medium-Range Recovery
MSAP	Maritime SAR Assistance Policy
MSB	Motor Surf Boat
MSC	Marine Safety Center
MSFCMA	Magnuson-Stevens Fisheries Conservation and Management Act
MSO	Maintenance Support Outline
MSO	Marine Safety Office
MSS	Marine Safety and Security
MSST	Maritime Safety and Security Team
MTL	Master Training List
MTS	Marine Transportation System



ACRONYM	DEFINITION
MTSNAC	Marine Transportation System National Advisory Council
MWR	Moral, Welfare and Recreation
NAFA	Non-Appropriated Fund Activity
NAVAIDS	Navigational Aids
NAVRULS	Navigation Rules
NCP	National Contingency Plan
NCW	Naval Coastal Warfare
NDRS	National Distress Response System
NDRSMP	National Distress Response System Modernization Project
NDS	National Distress System
NESU	Naval Engineering Support Unit
NJP	Non-Judicial Punishment
NLB	Nearshore Life Boat
NLT	No Later Than
NM	Nautical Miles
NMEA	National Marine Electronics Association
NMFS	National Marine Fisheries Service
NMLBS	National Motor Lifeboat School
NOS	National Ocean Survey
NOAA	National Oceanic and Atmospheric Administration
NRC	National Response Center
NRT	National Response Team
NSARC	National Search and Rescue Committee
NSB	Non-Standard Boat
NSF	National Strike Force
NSFCC	National Strike Force Coordination Center
NSN	National Stock Number
NSP	National Search and Rescue Plan
NSS	National Search and Rescue Supplement
NTP	Naval Training Publication
NVDC	National Vessel Documentation Center
NVIC	Navigation and Vessel Inspection Circular
NWP	Naval Warfare Publication



ACRONYM	DEFINITION
OBA	Oxygen Breathing Apparatus
O/S WX	On-Scene Weather
OCMI	Officer-in-Charge Marine Inspection
OER	Officer Evaluation Report
OIC	Officer-in-Charge
OIC INT	Officer in Charge's Initials
OJT	On-the-Job Training
OM & S	Operating Materials and Supplies
OMMP	Occupational Medical Monitoring Program
OOD	Officer of the Deck (Day)
OPA	Oil Pollution Act
OPAREA	Operational Area
OPCEN	Operations Center
OPCON	Operational Control
OPFAC	Operating Facility
OPLAN	Operations Plan
OPORD	Operations Order
OPORDER	Operations Order
OQB	Operations Qualification Board
ORM	Operational Risk Management
OS	Operations Specialist
OSB	Operations Standards Board
OSC	Operations Systems Center
OSC	On-Scene Commander
OSHA	Occupational Safety and Health Administration
OTC	Officer in Tactical Command
PA	Privacy Act
PAL	Personnel Allowance List
PALMS	Patrol Order Management System
PAO	Public Affairs Officer
PATCOM	Patrol Commander
PAWSS	Ports and Waterways Safety System
PCS	Permanent Change of Station



ACRONYM	DEFINITION
PDD	Presidential Decision Directive
PDR	Personnel Data Record
PDS	Personnel Data System
PERSRU	Personnel Reporting Unit
PES	Port and Environmental Safety
PFD	Personal Flotation Device
PI	Personnel Inspection
PIAT	Public Information Assistance Team
PIE	Partnership in Education
PIW	Person-in-the-Water
PLB	Personal Locator Beacon
PMIS/JUMPS	Personnel Management Information System/Joint Uniform Military Pay System
PMLV	Personnel Marker Light
PMS	Preventative/Planned Maintenance System
PO	Petty Officer
POB	Persons Onboard
POD	Probability of Detection
POP	Planned Obligation Priority
POS	Probability of Success
POPFAC	Parent Operating Facility
POW	Plan of the Week
PPE	Personal Protective Equipment
PPI	Plan Position Indicator
PPS	Precise Positioning Service
PQS	Personnel Qualification Standard
PR	Position Report
PRECOM	Preliminary Communications
PREP	Preparedness for Response Exercise Program
PS	Parallel Search
PSCO	Port State Control Officer
PSU	Port Security Unit
PTO	Power Take-Off
PWB	Port and Waterways Boat



ACRONYM	DEFINITION
PWSA	Ports and Waterway Safety Act
QAWTD	Quick-Acting Watertight Door
QEB	Qualification Examining Board
QRC	Quick Response Card
RACON	Radar Beacon
RB-HS	Response Boat-Homeland Security
RB-M	Response Boat-Medium
RBS	Recreational Boating Safety
RB-S	Response Boat-Small
RCC	Rescue Coordination Center
RDF	Radio Direction Finder
RFMC	Regional Fisheries Management Council
RFMO	Regional Fisheries Management Organization
RFO	Ready for Operations
RIK	Rations-In-Kind
RMS	Readiness Management System
RNAV	Radio Aids to Navigation
ROC/POE	Required Operational Capability/Point of Entry
RP	Responsible Party
RPAL	Reserve Personnel Allowance List
RS	Rescue Swimmer
RSC	Rescue Sub-Center
RT	Receiver/Transmitter
SAFE	Substance Abuse Free Environment
SAI	Small Arms Instructor
SAP	Simplified Acquisition Procedures
SAR	Search and Rescue
SAREX	SAR Exercise
SARMIS	Search and Rescue Mission Information System
SARSAT	Search and Rescue Satellite Aided Tracking
SAT	Subsistence Advisory Team
SATCOM	Satellite Communication
SB	Sailboat



ACRONYM	DEFINITION
SC	SAR Coordinator
SCUBA	Self-Contained Underwater Breathing Apparatus
SDB	Service Dress Blue
SDO	Sector Duty Officer
SEAOP	Special and Emergency Operations Procedure
SEPRATS	Separate Rations
SF	Safety Factor
SIGINT	Signals Intelligence
SIPRNET	Secret Internet Protocol Routing Network
SITREP	Situation Report
SKF	Skiff
SLDMB	Self Locating Datum Marker Buoy
SMC	SAR Mission Coordinator
SMS	Safety Management System
SMTJ	Special Maritime and Territorial Jurisdiction
SNO	Statement of No Objection
SOA	Speed of Advance
SOG	Speed Over Ground
SOLAS	Safety of Life at Sea
SO-OP	Auxiliary Division Operations Officer
SOP	Standard Operating Procedure
SOPA	Senior Officer Present Afloat
SOPEP	Shipboard Oil Pollution Emergency Plan
SOQ	Sailor of the Quarter
SOS	Save Our Ship
SPC	Special Purpose Craft
SPC (HWX)	Heavy Weather Special Purpose Craft
SPC (LE)	Special Purpose Craft (Law Enforcement)
SPE	Severity-Probability-Exposure
SPF	Sun Protection Factor
SPOC	SAR Point of Contact
SPS	Standard Positioning Service
SRA	Short-Range Aids to Navigation



ACRONYM	DEFINITION
SROE	Standing Rules of Engagement
SRR	Search and Rescue Region
SRR	Short-Range Recovery
SRS	Synchronous Reference Sensor
SRU	Search and Rescue Unit
SS	Square Search
SSB	Single Side Band
SSB-HF	Single Side Band - High Frequency
SSL	Standard Support Level
SSM	Support and Special Mission
SSMR	Shore Station Maintenance Record
SSPO	Station Support Petty Officer
STA OPS	Station Operations
STAN & RFO	Readiness and Standardization Program
STANT	Station Aids to Navigation Team
STAR	Standard Automated Requisitioning
STCW	Standards of Training, Certification and Watchkeeping for Seafarers
STTR	Short Term Resident Training Request
STU III	Secure Telephone Unit
SURPIC	Surface Picture
SWE	Service-wide Exam
SWL	Safe Working Load
TACON	Tactical Control
TAD	Temporary Assigned Duty
TAIT	Temporary Access Inventory Tool
TANB	Trailerable Aids to Navigation Boat
TB	Tuberculosis
TBSA	Total Body Surface Area
TC	Technical Committee
TCM	Telecommunications Manual
TCOW	Telecommunications Watchstander
TCT	Team Coordination Training
TD	Temporary Duty



ACRONYM	DEFINITION
TD	Time Difference
TFC	Total Fuel Consumption
THREATCON	Threat Conditions
TMT	Training Management Tool
TOI	Target of Interest
TPSB	Transportable Port Security Boat
TQC	Training Quota Management Center
TRACEN	Training Center
TRATEAM	Training Team
TRS	Timing Reference Sensor
TSN	Track Line Non-Return Search
TSR	Track Line Return Search
U/W	Underway
UCMJ	Uniform Code of Military Justice
UEG	Unit Environmental Guide
UEPH	Unaccompanied Enlisted Personnel Housing
UHF	Ultra High Frequency
UMI	Universal Marine Interface
UMIB	Urgent Marine Information Broadcast
UOF	Use of Force
UPF	Unit Performance Factor
UPH	Unaccompanied Personnel Housing
UPS	United Parcel Service
USBP	United States Border Patrol
USC	United States Code
USFWS	U.S. Fish and Wildlife Service
USPS	U.S. Power Squadron
USWMS	Uniform State Waterway Marking System
UTB	Utility Boat
UTBSC	Utility Boat Systems Center
UTC	Coordinated Universal Time
UTL	Utility Boat Light
UTM	Utility Boat Medium



ACRONYM	DEFINITION
UTS	Unit Travel System
UV	Ultraviolet
VHA	Variable Housing Allowance
VHF	Very High Frequency
VRM	Variable Range Marker
VRO	Variable Ratio Oiler
VRP	Vessel Response Plan
VS	Sector Search
VSC	Vessel Safety Check
VTS	Vessel Traffic Services
WP	Working Punt
WAAS	Wide Area Augmentation System
WAMS	Waterways Analysis and Management System
WC	Wellness Coordinator
WLIC	Construction Tender
WLL	Working Load Limit
WPB	Patrol Boat
WR	Wellness Representative
WWM	Waterways Management
XO	Executive Officer
XPO	Executive Petty Officer
XTE	Cross Track Error